



AFTERMARKET



Auszug: Zubehör

Excerpt: Accessories



MOTORRAD | MOTORCYCLE 2019



Fußrastenanlagen

Rear sets



Racing Rastenanlagen mit ABE Rear sets for racing, TÜV approved

MIT ABE,
KEIN TÜV
NÖTIG!



SP-EDITION

- hochwertige Rastenanlagen für ambitionierte Sportfahrer
- individuelle Einstellung der Sitzposition
 - 28,5 mm →
 - 18 mm ↑
- made in Germany
- präzise mit CNC gefräst
- edle, schwarz eloxierte Oberfläche
- superleichte Ausführung aus hochwertigem Aluminium
- mit klappbarer Fußraste (starre Racing-Raste im Zubehör erhältlich)

SP-EDITION

- high-grade rear sets for ambitious sports riders
- individual adjustment of the sitting position
 - 28.5 mm →
 - 18 mm ↑
- made in Germany
- high-precision CNC-milled
- elegant, black anodized surface
- super-lightweight design, made from high-grade aluminium
- foot rests can be folded up (rigid racing foot rests available as accessories)

Einbaubeispiel Suzuki GSX-R 1000, Artikel-Nr. MCF141SP | Installation example Suzuki GSX-R 1000, article no. MCF141SP

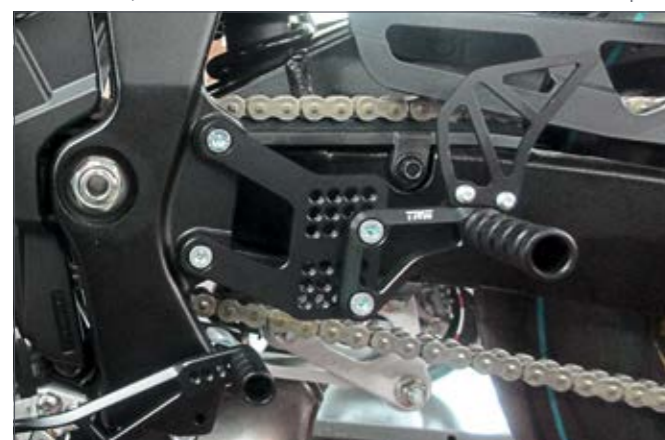

Schaltseite | Gear side



Bremsseite | Brake side

Jetzt Video anschauen!
Watch our video!

ENTDECKE
DIE FUSSRASTEN-
ANLAGE IN UNSEREM
VIDEO:

DISCOVER THE REAR SET
IN OUR VIDEO CLIP:



D



EN



TRW Fußrastenanlage SP Edition

Erlebe die TRW Fußrastenanlage im Video aus neuen Perspektiven. Sie gibt deinem Bike eine noch sportlichere Optik und lässt sich perfekt auf deine Sitzposition einstellen. Mit ABE – also auch für die Straße die erste Wahl.

TRW rearset, SP edition

Experience the TRW rearset in the video from new perspectives. It gives your bike a sportier appearance and can be optimally adjusted to your seat position. With ABE certification, it is the first choice for the road as well.

trwmoto.com

Schalttypen Shifting types

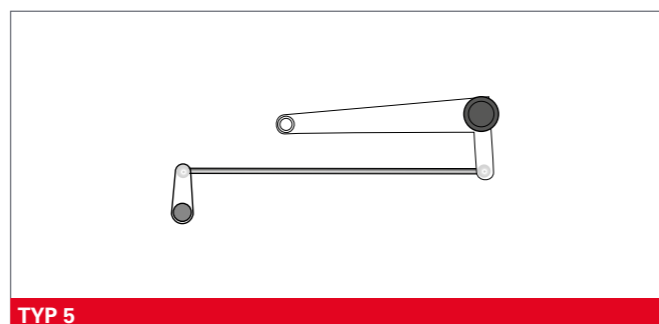
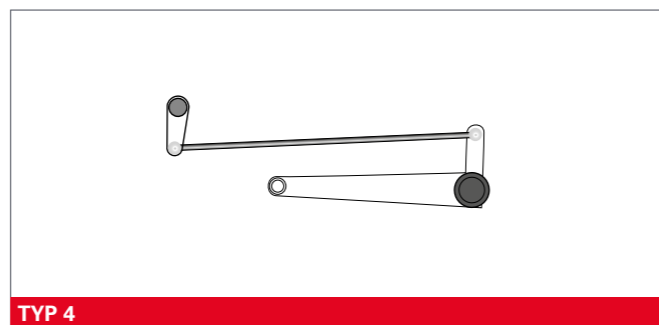
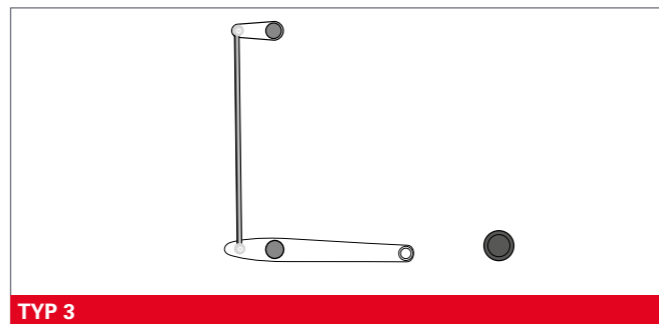
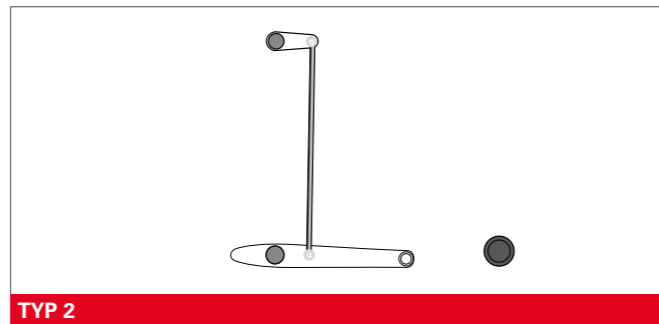
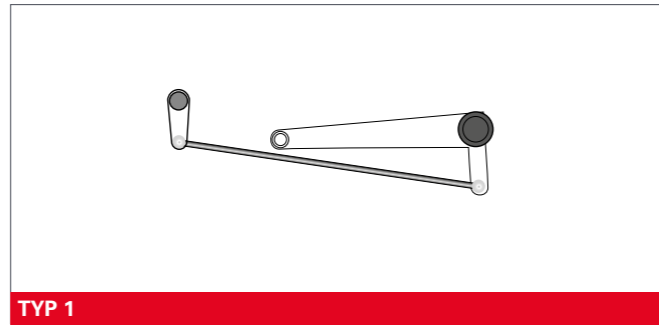

Schaltumkehrungen Reverse gearshifts

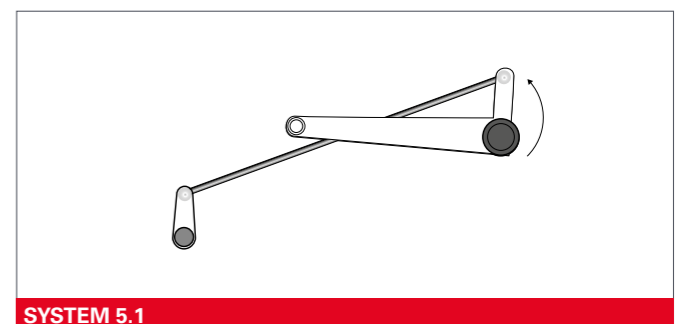
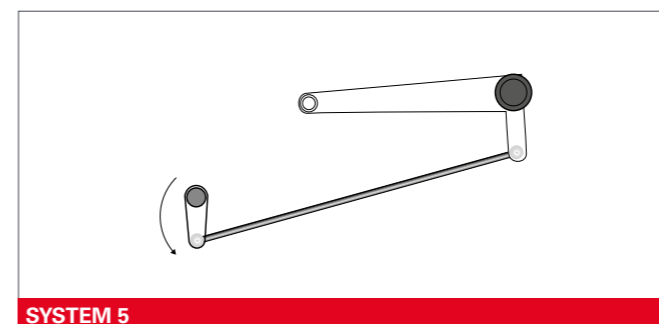
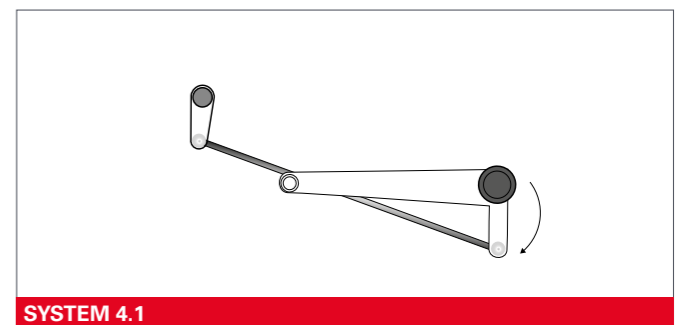
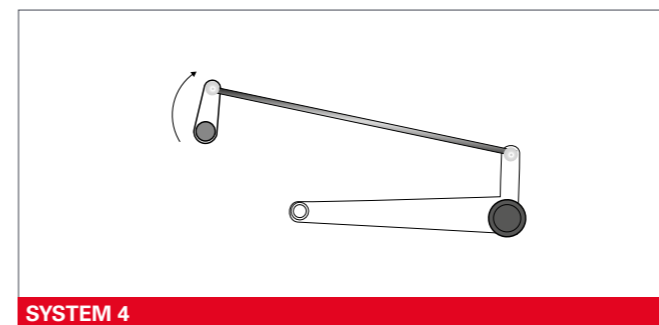
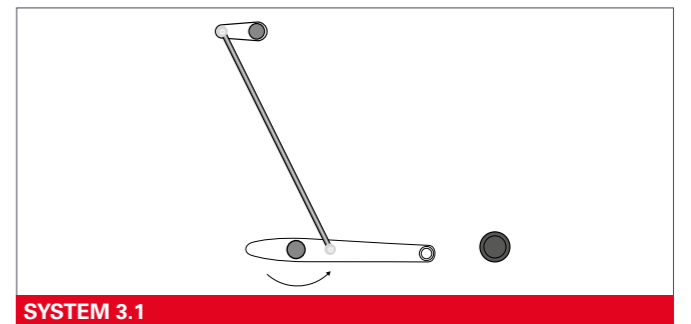
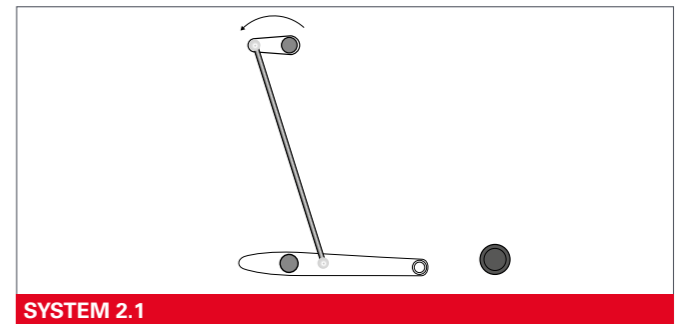
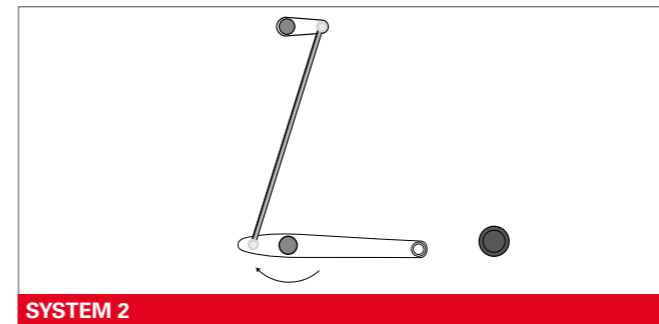
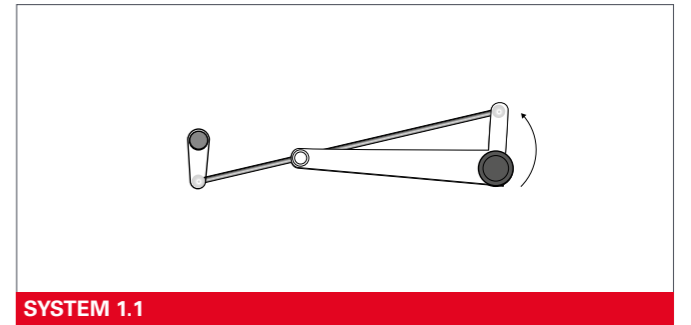
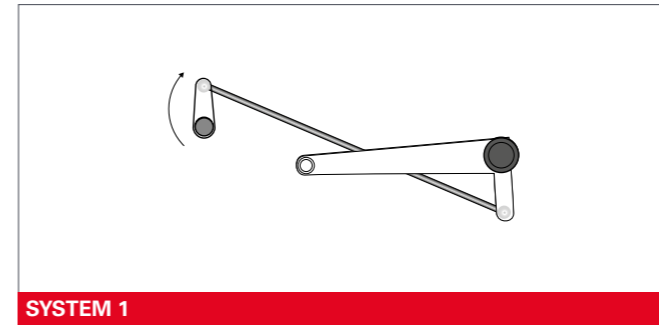

Schalttypen Shifting types

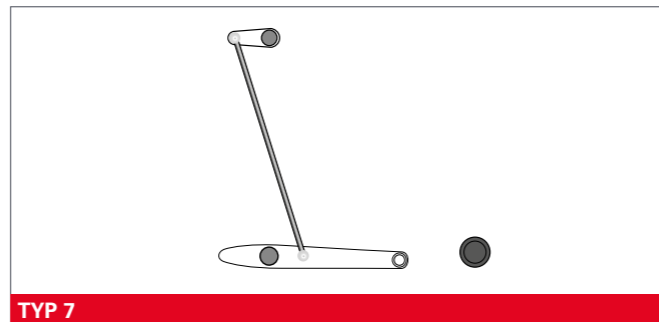
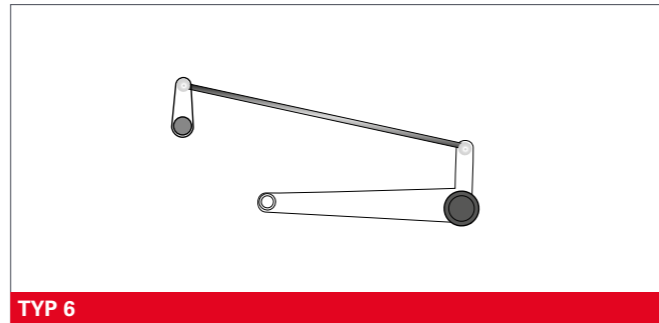

Aprilia							
RSV	1000	Mille	ME	98-01	MCF106SP	Typ 1	System 1 8)
RSV	1000	Mille	RP	01-03	MCF106SP	Typ 1	System 1 8)
RSV	1000	Mille R	ME	00	MCF106SP	Typ 1	System 1 8)
RSV	1000	Mille R	RP	01-03	MCF106SP	Typ 1	System 1 8)
RSV	1000	R, R Factory	RR	04-10	MCF107SP	Typ 1	System 1 17)
RSV	1000	Tuono R	RP	02-05	MCF106SP	Typ 1	System 1 8)
RSV	1000	Tuono R	RR	06-08	MCF107SP	Typ 1	System 1 17)
RSV	1000	Tuono R Factory	RR	06-11	MCF107SP	Typ 1	System 1 17)
RSV4	1000	Factory	RK	09-12	MCF108SP	Typ 5	— 15), 19)
RSV4	1000	R	RK	10-13	MCF105SP	Typ 5	— 15), 21)
RSV4	1000	R APRC	RK	10-15	MCF105SP	Typ 5	— 15), 21)
RSV4	1000	R APRC ABS	RK	13-14	MCF105SP	Typ 5	— 4) MCH43FR, 15), 21), 22)
RSV4	1000	Factory APRC	RK	11-15	MCF105SP	Typ 5	— 15), 21)
RSV4	1000	RR	RK	15-16	MCF105SP	Typ 5	— 4) MCH43FR, 15), 21), 22)
RSV4	1000	RF	RK	15-16	MCF105SP	Typ 5	— 4) MCH43FR, 15), 21), 22)
RSV4	1000	RR	KE	17-	MCF143SP	Typ 5	— 4) MCH46FR, 15), 21), 22), 25)
RSV4	1000	RF	KE	17-	MCF143SP	Typ 5	— 4) MCH46FR, 15), 21), 22), 25)
V4	1000	R Tuono	TY	11-14	MCF108SP	Typ 5	— 15), 19)
V4	1000	R Tuono APRC	TY	11-14	MCF105SP	Typ 5	— 15), 21)
V4	1100	RR Tuono	TY	15-16	MCF105SP	Typ 5	— 4) MCH43FR, 15), 21), 22)
V4	1100	Tuono Factory	TY	15-16	MCF105SP	Typ 5	— 4) MCH43FR, 15), 21), 22)
V4	1100	Tuono, RR	KG	17-	MCF143SP	Typ 5	— 4) MCH46FR, 15), 21), 22), 25)
BMW							
F	800	R	E8ST	15-16	MCF112SP	Typ 1	— 4) MCH59FR, 15), 19), 25)
S	1000	R	K10	09-15	MCF102SP	Typ 4	— 7), 14), 15)
S	1000	RR	K10	09-15	MCF102SP	Typ 4	— 7), 14), 15)
S	1000	RR	K10	09-15	MCF102SP-UM	—	System 2 9), 14), 16)
S	1000	RR	2R10	16	MCF100SP	Typ 3	System 2
S	1000	R, RR	2R10	17-18	MCF155SP	Typ 3	System 3.1 20), 25)
S	1000	R, RR	2R10r	17-18	MCF155SP	Typ 3	System 3.1 20), 25)

Schaltumkehrungen Reverse gearshifts

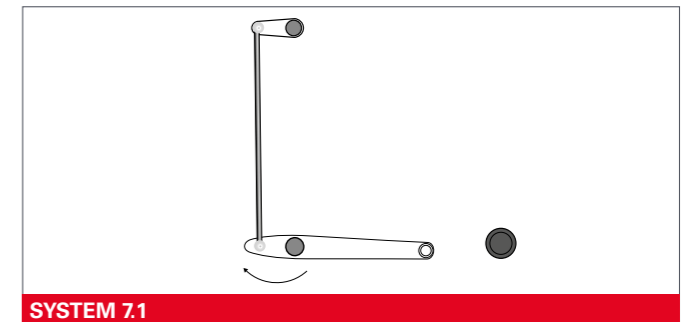
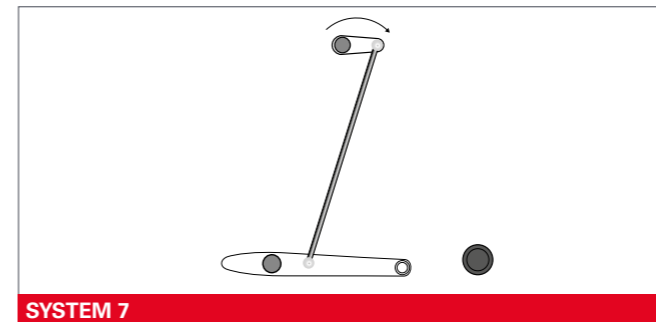
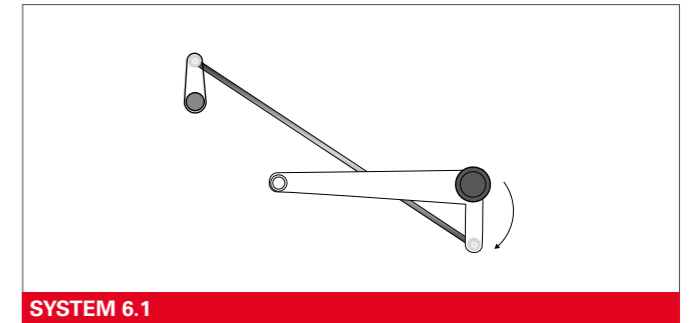
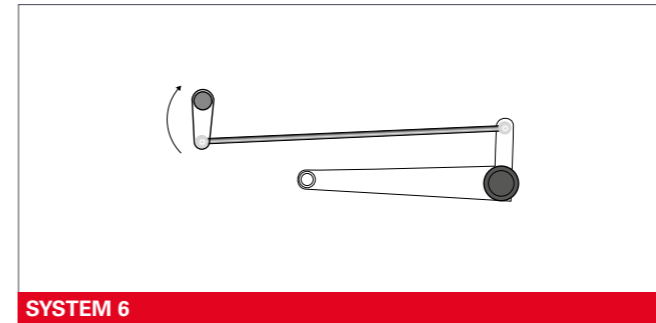

Ducati							
796	Hypermotard	B1	10-12	MCF109SP	Typ 6	—	1), 6), 11), 15), 25)
848		H6	08-10	MCF118SP	Typ 1	System 1	1)
848	EVO	H6	10-14	MCF118SP	Typ 1	System 1	
899	Panigale ABS	H8	13-15	MCF126SP	Typ 4	—	4) MCH54FR, 14), 15)
1098	R, S	H7	07-09	MCF118SP	Typ 1	System 1	1), 19)
1100	Hypermotard S	B1	07-12	MCF109SP	Typ 6	—	1), 6), 11), 15), 25)
1100	Hypermotard Evo, SP	B1	07-12	MCF109SP	Typ 6	—	1), 6), 11), 15), 25)
1198		H7	07-09	MCF118SP	Typ 1	System 1	1), 19)
1198	R, S, SP	H7	07-09	MCF118SP	Typ 1	System 1	1), 19)
1199	Panigale, S, R, ABS	H8	12-17	MCF111SP	Typ 4	—	4) MCH66FR, 14), 15)
1299	Panigale, S, R, ABS	H9	15-	MCF126SP	Typ 4	—	4) MCH54FR, 14), 15)
1100	Panigale V4, S, Speciale	DA	18-	MCF129SP	Typ 4	System 4.1	4) MCH41FR, 7), 14), 20), 22), 23), 25)
Honda							
CBR	125	R	JC50	11-17	MCF114SP	Typ 1	— 1), 15), 24), 25)
CBR	600	F	PC35	99-07	MCF128SP	Typ 1	System 1
CBR	600	RR	PC40	07-17	MCF194SP	Typ 1	System 4 9)
CBR	900	RR	SC44	00-01	MCF191SP	Typ 1	System 1
CBR	954	RR	SC50	02-03	MCF191SP	Typ 1	System 1
CBR	1000	RR Fireblade	SC57	04-07	MCF195SP	Typ 2	System 2
CBR	1000	RR Fireblade	SC59	08-16	MCF116SP	Typ 2	System 2
CBR	1000	RA Fireblade ABS	SC59	08-16	MCF116SP	Typ 2	System 2 4) MCH20FR
CBR	1000	RR Fireblade	SC77	17-	MCF127SP	Typ 2	— 4) MCH71FR, 14), 15), 20)
CBR	1000	RR Fireblade	SC77	17-	MCF127SP-UM	—	System 2 4) MCH71FR, 9), 14), 16), 20)
CB	1000	R	SC60	08-16	MCF119SP	Typ 2	— 15)
CB	1000	RA ABS	SC60	08-16	MCF119SP	Typ 2	— 4) MCH40FR, 15)
Kawasaki							
400	Ninja	EX400G	18	MCF137SP			in Vorbereitung
ZX-6RR	600	Ninja	ZX600N	05-06	MCF198SP	Typ 1	System 1 4) MCH25FR
ZX-6R	600	Ninja	ZX600P	07-08	MCF198SP	Typ 1	System 1 4) MCH362H1
ZX-6R	600	Ninja	ZX600R	09-13	MCF198SP	Typ 1	System 1 4) MCH282H1

Motorcycle		Hourglass	Person	Key	Key with arrow	Info	
ZX-6R	636 Ninja	ZX636C	05-06	MCF198SP	Typ 1	System 1	4) MCH25FR
Z	650	ER650H, ER650HA2	17-	MCF136SP	Typ 4	---	4) MCH49FR, 15), 22), 25)
	650 Ninja	EX650K, EX650KA2	17-	MCF136SP	Typ 4	---	4) MCH49FR, 15), 22), 25)
Z	750	ZR750L(L,M)	07-15	MCF115SP	Typ 1	System 1	
Z	750 ABS	ZR750L(L,M)	07-15	MCF115SP	Typ 1	System 1	4) MCH45FR
Z	900	ZR900B	17-	MCF142SP	Typ 1	System 1	1), 19), 25)
Z	1000	ZRT00B(B,C)	07-09	MCF115SP	Typ 1	System 1	
Z	1000 ABS	ZRT00B(B,C)	07-09	MCF115SP	Typ 1	System 1	4) MCH45FR
Z	1000	ZRT00D(D,E)	10-13	MCF172SP	Typ 1	---	
Z	1000	ZRT00F	14-	MCF172SP	Typ 1	---	
Z	1000 SX	ZXT00G(H)	10-13	MCF172SP	Typ 1	---	
Z	1000 SX Tourer	ZXT00L, ZXT00W	14-18	MCF172SP	Typ 1	---	
ZX-10R	1000 Ninja	ZXT00E	08-09	MCF117SP	Typ 1	System 1	
ZX-10R	1000 Ninja	ZXT00F	10	MCF117SP	Typ 1	System 1	10)
ZX-10R	1000 Ninja ABS	ZXT00F	10	MCF117SP	Typ 1	System 1	4) MCH90FR, 10)
ZX-10R	1000 Ninja	ZXT00J(J)	11-15	MCF173SP	Typ 1	System 1	10)
ZX-10R	1000 Ninja ABS	ZXT00J(K)	11-15	MCF173SP	Typ 1	System 1	4) MCH90FR, 10)
ZX-10R	1000 Ninja ABS, Quickshifter	ZXT00S	16-	MCF174SP	Typ 1	---	4) MCH90FR, 15)
KTM							
	1290 Superduke R		14-	MCF180SP	Typ 1	---	15), 19)
Suzuki							
GSX-R	600	AD	97-00	MCF183SP	Typ 1	System 1	
GSX-R	600	WVBG	01-03	MCF183SP	Typ 1	System 1	
GSX-R	600	WVB2	04-05	MCF183SP	Typ 1	System 1	
GSX-R	600	WVCE	06-07	MCF187SP	Typ 3	System 3	
GSX-R	600	WVCV	08-10	MCF187SP	Typ 3	System 3	
GSF	600 Bandit	GN77B	94-99	MCF145SP	Typ 1	System 1	
GSF	600 Bandit	WVA8	00-04	MCF145SP	Typ 1	System 1	
GSF	650 Bandit	WVB5	05-06	MCF145SP	Typ 1	System 1	
GSF	650 Bandit	WVCJ	07-09	MCF113SP	Typ 2	---	15)
GSX	650 F, A ABS	WVCJ	09-16	MCF113SP	Typ 2	---	15)
SV	650	AV	98-02	MCF181SP	Typ 1	System 1	
SV	650	WVBY	03-09	MCF181SP	Typ 1	System 1	
SV	650	CX	16-	MCF185SP	Typ 5	---	15), 19)
GSR	750 A ABS	WVC5	11-16	MCF182SP	Typ 1	System 1	
GSX-R	750	WVBD	00-03	MCF183SP	Typ 1	System 1	
GSX-R	750	WVB3	04-05	MCF183SP	Typ 1	System 1	
GSX-R	750	WVCF	06-07	MCF187SP	Typ 3	System 3	
GSX-R	750	WVCW	08-10	MCF187SP	Typ 3	System 3	
GSX-S	750	C5	17-	MCF124SP	Typ 5	---	15)
GSX-R	1000	WVBL	01-02	MCF183SP	Typ 1	System 1	
GSX-R	1000	WVBZ	03-04	MCF183SP	Typ 1	System 1	
GSX-R	1000	WVB6	05-06	MCF186SP	Typ 1	System 1	
GSX-R	1000	WVCL	07-08	MCF196SP	Typ 1	System 1	
GSX-R	1000	WVCY	09-16	MCF188SP	Typ 3	System 3	
GSX-R	1000	DM	17-	MCF141SP	Typ 7	System 7	14)
GSX-S	1000 A, FA	DG	15-17	MCF184SP	Typ 1	System 1	
SV	1000	WVBX	03-05	MCF181SP	Typ 1	System 1	4) MCH30FR, 8), 11)
GSF	1200 Bandit	GV75A	96-00	MCF145SP	Typ 1	System 1	
GSF	1200 Bandit	WVA9	01-05	MCF145SP	Typ 1	System 1	
GSF	1200 Bandit	WVCB	06	MCF145SP	Typ 1	System 1	
GSF	1250 A Bandit	WVCH	07-17	MCF113SP	Typ 2	---	15)
GSX	1250 FA	WVCH	10-17	MCF113SP	Typ 2	---	15)
GSX	1300 R Hayabusa	WVA1	99-07	MCF166SP	Typ 1	---	15)
GSX	1300 R Hayabusa, ABS	WVCK	08-12	MCF166SP	Typ 1	---	15)
GSX	1300 B-King	WVCR	07-11	MCF163SP	Typ 1	System 1	
GSX	1300 B-King ABS	WVCR	07-11	MCF163SP	Typ 1	System 1	4) MCH55FR

Motorcycle		Hourglass	Person	Key	Key with arrow	Info	
Triumph							
	675 Daytona	D67LC	06-11	MCF197SP	Typ 4	---	14), 15)
	675 Daytona	D67LC	06-11	MCF197SP-UM	---	System 3	5), 16)
	675 Street Triple, ABS	D67LD	08-12	MCF197SP	Typ 4	---	15)
	675 Street Triple, ABS	D67LD	08-12	MCF197SP-UM	---	System 3	5), 16)
	675 Street Triple, R	L67LR	13-17	MCF190SP-UM	---	System 3	16)
	675 Street Triple ABS	L67LR	13-17	MCF190SP	Typ 4	---	4) MCH50FR, 15)
	675 Street Triple ABS	L67LR	13-17	MCF190SP-UM	---	System 3	4) MCH50FR, 16)
	675 Daytona R	H67	12-17	MCF190SP	Typ 4	---	15)
	675 Daytona R	H67	12-17	MCF190SP-UM	---	System 3	16)
	675 Daytona R ABS	H67	12-17	MCF190SP	Typ 4	---	4) MCH50FR, 15)
	675 Daytona R ABS	H67	12-17	MCF190SP-UM	---	System 3	4) MCH50FR, 16)
	765 Street Triple S, R, RS	HD01	17-	MCF192SP	Typ 4	---	4) MCH47FR, 7), 14), 15), 20), 22), 25)
	1050 Speed Triple	515NV	11-15	MCF193SP	Typ 1	---	13), 15)
	1050 Speed Triple ABS	515NV	11-15	MCF193SP	Typ 1	---	13), 15)
	1050 Speed Triple S&R	NN01	16-17	MCF121SP	Typ 5	---	4) MCH48FR, 7), 14), 15), 20), 22), 25)
	1050 Speed Triple S&R	NN01	18-	MCF135SP	Typ 5	---	4) MCH80FR, 7), 14), 15), 20), 25)
Yamaha							
YZF	125 R	RE06	08-14	MCF150SP	Typ 4	---	15)
XJ6	600	RJ19/RJ22	09-16	MCF153SP	Typ 6	---	6), 15), 17), 19)
YZF	600 R6	RJ11	06-07	MCF169SP	Typ 3	System 3	
YZF	600 R6	RJ15	08-17	MCF169SP	Typ 3	System 3	
YZF	600 R6	RJ27	17-	MCF179SP	Typ 3	System 3.1	4) MCH44FR, 21), 22), 23)
FZ8	800 N Fazer, S Fazer	RN25	10-17	MCF164SP	Typ 4	---	15)
MT-09	850	RN29	13-16	MCF104SP	Typ 2	System 1	
MT-09	847	RN43	17-	MCF171SP	Typ 1	System 1.1	21), 25)
MT-10	1000	RN45	16-	MCF170SP	Typ 3	System 3.1	
FZ1	1000 S Fazer	RN16	06-16	MCF164SP	Typ 4	---	4) MCH64FR, 7), 12), 15)
FZ1	1000 S Fazer ABS	RN16	07	MCF164SP	Typ 4	---	4) MCH60FR, 7), 12), 15)
YZF	1000 R1	RN12	04-06	MCF168SP	Typ 4	System 4	13)
YZF	1000 R1	RN19	06-08	MCF199SP	Typ 3	System 2	10)
YZF	1000 R1	RN32	15-17	MCF161SP	Typ 3	System 2	

- 1) Bremszylinder an der Rastenanlage montiert
- 4) geänderte Bremsleitung notwendig: Art.-Nr. ...
- 5) Ritzelabdeckung entfernen
- 6) ohne Soziusraste
- 7) Schaltung durch den Rahmen
- 8) Kürzung Kolbenstange am Bremszylinder notwendig
- 9) Modifikation der Verkleidung notwendig
- 10) bei Umkehrschaltung, Ritzelabdeckung entfernen
- 11) eingeschränkter Verstellbereich
- 12) gebogene Schaltstange
- 13) Schaltung außerhalb des Rahmens
- 14) auch mit Quickshifter
- 15) nur Standard-Schaltschema möglich
- 16) nur Umkehrschaltung möglich
- 17) geänderte Verlegung der Bremsleitung notwendig
- 19) nur Modelle ohne Quickshifter
- 20) auch für Modelle ohne Quickshifter
- 21) nur für Modelle mit Quickshifter
- 22) nur für Modelle mit ABS
- 23) Zulaufschlauch Bremsflüssigkeiten ersetzen
- 24) Zulaufschlauch Bremsflüssigkeit kürzen
- 25) Rastenposition weicht vom Standard ab

- 1) brake cylinder mounted on the rear set
- 4) altered brake line required: art. No. ...
- 5) remove pinion cover
- 6) without pillion foot rest
- 7) shifting through the frame
- 8) shorter piston rod on brake cylinder required
- 9) modification of fairing required
- 10) remove pinion cover for reverse gearshift
- 11) limited adjustment range
- 12) curved gearshift rod
- 13) shifting outside the frame
- 14) also with quickshift
- 15) only standard shifting scheme possible
- 16) only reverse gearshift possible
- 17) routing of brake line has to be changed
- 19) only models without quickshift
- 20) also for models without quick shifter
- 21) only for models with quick shifter
- 22) only for models with ABS
- 23) replace feed hose for brake fluid
- 24) shorten feed hose for brake fluid
- 25) footpeg position deviates from the standard

Typen und Schaltumkehrungen siehe Seite 5.04 - 5.07

Types and reverse gearshifts see pages 5.04 - 5.07

Ersatzteile und Zubehör Spare parts and accessories

ERSATZHEBEL | REPLACEMENT LEVER



Siehe Seite 5.13 | See page 5.13

MITNEHMER FÜR HEBEL ACTUATOR ARM FOR LEVER



VE: 1 Stück | Selling unit: 1 piece

Bestell-Nr. Order no.	
←	→
MCF940L	MCF940R

KUGELGELENKKOPF TIE ROD END



Aus Edelstahl | Made of stainless steel

Bestell-Nr. Order no.		
Bohrung Bore	Gewinde Thread	Gewinde Thread
Ø 6 mm *	MCF930	MCF931
Ø 8 mm *	MCF932	-
Ø 6 mm **	MCF933	MCF934

SCHALTSTANGENVERLÄNGERUNG SHIFT ROD EXTENSION

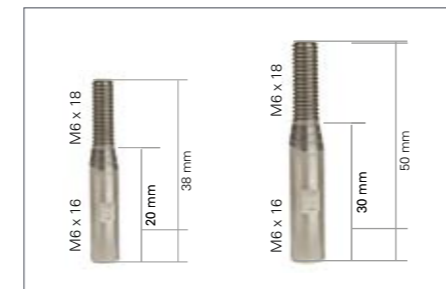

Aus Edelstahl | Made of stainless steel

Bestell-Nr. Order no.	
Verlängerung Extension	Außen-/Innengewinde outer/inner thread
20 mm	MCF420
30 mm	MCF430

AUSTAUSCHRASTE INKL. SCHRAUBE, STARR – RACING, SP FOOTREST INCL. SCREW, RIGID – RACING, SP



Verkaufseinheit: 1 Stück, ohne ABE – nur für Racing
Selling unit: 1 piece, without ABE – racing only

Bestell-Nr. Order no.	
MCF942 S	

AUSTAUSCHRASTE INKL. SCHRAUBE, KLAPPBAR REPLACEMENT PEG INCL. SCREW, FOLDABLE



Verkaufseinheit: 1 Stück
Selling unit: 1 piece

Bestell-Nr. Order no.	
MCF941 S	

ERSATZSTOPFEN | REPLACEMENT STOPPERS



Verkaufseinheit: 2 Stück | Selling unit: 2 pieces

Bestell-Nr. Order no.	
MCF905S	

HYDRAULISCHER BREMSLICHTSCHALTER | HYDRAULIC BRAKE LIGHT SWITCH



Bestell-Nr. Order no.	
Ø = M10 x 1.0	MCF935
Ø = M10 x 1.25	MCF936



Bestell-Nr. Order no.	
Ø = M10 x 1.0	MCF937
Ø = M10 x 1.25	MCF938

BREMFLÜSSIGKEITSBEHÄLTER, 15 ML | BRAKE FLUID CONTAINER, 15 ML



Kunststoff | Plastic



Kunststoff | Plastic

Bestell-Nr. Order no.	
gerade straight	MCZ530
schräg diagonal	MCZ531



Aluminium, MCZ530...



Aluminium, MCZ531...

Bestell-Nr. Order no.			
MCZ530 S		MCZ531 S	
MCZ530 C		MCZ531 C	

ADAPTER ZUR VERLEGUNG VON BREMSFLÜSSIGKEITSBEHÄLTERN ADAPTER FOR RELOCATING BRAKE FLUID RESERVOIRS

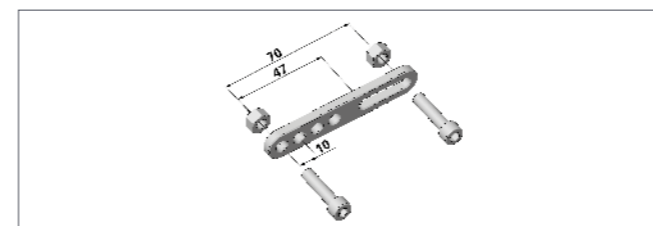

Bestell-Nr. Order no.	
MCF440 S	
MCF440 C	



FERSENSCHUTZ LINKS

- aus Aluminium
- für SP-Version

HEEL PROTECTION LEFT

- made of aluminium
- for SP-version



FERSENSCHUTZ UNIVERSAL

- aus Carbon
- für SP- und RAC-Version

HEEL PROTECTION UNIVERSAL

- made of carbon
- for SP- and RAC-version



FERSENSCHUTZ RECHTS

- aus Aluminium
- für SP- und RAC-Version

HEEL PROTECTION RIGHT

- made of aluminium
- for SP- and RAC-version



FERSENSCHUTZ RECHTS

- aus Aluminium
- für SP- und RAC-Version

HEEL PROTECTION RIGHT

- made of aluminium
- for SP- and RAC-version

Bohrung Bore	Bestell-Nr. Order no.
Ø 6 mm	MCF923S
Ø 8 mm	MCF924S

Bestell-Nr. Order no.
MCF927 L

Bestell-Nr. Order no.
MCF928

Bestell-Nr. Order no.
MCF925 S

FUSSBREMSZYLINDER

- CNC-gefräst, hochfestes Aluminium
- variable Befestigungspunkte, 37 - 50 mm
- passend für alle TRW Fußrastenanlagen
- eignet sich ebenfalls für Fremdfabrikate
- Betätigung über Kugelgelenk M8
- Kolbendurchmesser 12,8 mm



FOOT BRAKE CYLINDER

- CNC-milled, in high-strength aluminium
- variable fixing points from 37 - 50 mm
- suitable for all TRW rear sets
- suitable for models from other manufacturers
- activation by M8 ball joint
- piston diameter 12.8 mm

Bestell-Nr. Order no.
MCF911 S
MCF911 G

**LEGENDE ERSATZTEILE UND ZUBEHÖR
KEY SPARE PARTS AND ACCESSORIES**

Artikel-Nr.	Schalt-hebel	Brems-hebel	Adapter-platte links	Adapter-platte rechts	Grund-platte links	Grund-platte rechts	Brems-zylinder halter	Schalt-stange Version 1*	Schalt-stange Version 2*	Schalt-stange Version 3*	Schalt-stange Version 4*	Fersen-schutz Schalt-seite	Fersen-schutz Bremse	Schrau-ben-Set	Buchsen-Set
Part no.	Gear Shifting Lever	Brake Lever	Adjuster Plate left	Adjuster Plate right	Base Plate left	Base Plate right	Brake Cylinder Bracket	Shifting Rod version 1*	Shifting Rod version 2*	Shifting Rod version 3*	Shifting Rod version 4*	Heel Guard left	Heel Guard right	Screw Kit	Bushing Kit

* Teilweise verschiedene Längen zur Auswahl; Beispiel: **MCF220X** = 220 mm Länge, **MCF200X** = 200 mm Länge

* Partly different lengths to choose from; example: **MCF220X** = 220 mm length, **MCF200X** = 200 mm length

MCF100SP	MCF582L	MCF507R	MCF444L	MCF444R	MCF600L	MCF600R	MCF523	2)								MCF927L	MCF923S	MCF800SK	MCF800BK	
MCF102SP	MCF574L	MCF507R	MCF414L	MCF414R	MCF600L	MCF600R	MCF523	2)									MCF927L	MCF923S	MCF802SK	MCF802BK
MCF102SP-UM	MCF560L	MCF507R	MCF414L	MCF414R	MCF600L	MCF600R	MCF523	MCF100Z									MCF927L	MCF923S	MCF835SK	MCF835BK
MCF103SP	MCF565L	MCF539R	MCF488L	MCF488R	MCF600L	MCF600R	MCF534	MCF220W									MCF928	MCF924S	MCF803SK	MCF804BK
MCF104SP	MCF565L	MCF503R	MCF434L	MCF434R	MCF600L	MCF600R	MCF500	MCF220X	MCF200X	MCF190X							MCF928	MCF924S	MCF804SK	MCF804BK
MCF105SP	MCF584L	MCF517R	MCF421L	MCF421R	MCF600L	MCF600R	MCF543	MCF160W	MCF185W								MCF927L	MCF923S	MCF805SK	MCF805BK
MCF106SP	MCF563L	MCF503R	MCF406L	MCF406R	MCF600L	MCF600R	MCF507	MCF150W	MCF160W								MCF927L	MCF923S	MCF806SK	MCF806BK
MCF107SP	MCF563L	MCF503R	MCF407L	MCF407R	MCF600L	MCF600R	MCF507	MCF150W	MCF175W								MCF927L	MCF923S	MCF807SK	MCF807BK
MCF108SP	MCF568L	MCF517R	MCF410L	MCF410R	MCF600L	MCF600R	MCF528	MCF175W	MCF195W								MCF927L	MCF923S	MCF808SK	MCF808BK
MCF108SP	MCF553L	MCF553R	MCF425L	MCF425R	3)	3)	3)	2)									MCF927L	MCF928	MCF809SK	MCF809BK
MCF110SP	MCF563L	MCF507R	MCF426L	MCF426R	3)	3)	3)	MCF165W									MCF928	MCF928	MCF810SK	
MCF111SP	MCF550L	MCF500R	MCF436L	MCF436R	MCF610L	MCF600R	MCF505	2)									MCF927L	MCF923S	MCF811SK	
MCF112SP	MCF566L	MCF504R	MCF449L	MCF449R	MCF600L	MCF600R	MCF542	MCF110W	MCF085W								MCF927L	MCF923S	MCF812SK	MCF812BK
MCF113SP	MCF572L	MCF506R	MCF405L	MCF405R	MCF600L	MCF600R	MCF520	2)									MCF927L	MCF924S	MCF813SK	MCF813BK
MCF114SP	MCF584L	MCF505R	MCF443L	MCF443R	MCF600L	MCF600R	MCF509	MCF220W	MCF235W								MCF927L	MCF923S	MCF814SK	MCF814BK
MCF115SP	MCF568L	MCF503R	MCF400L	MCF400R	MCF600L	MCF600R	MCF517	MCF180Y	MCF195Y								MCF927L	MCF924S	MCF815SK	MCF815BK
MCF116SP	MCF580L	MCF502R	MCF402L	MCF402R	MCF600L	MCF600R	MCF516	MCF160W									MCF927L	MCF923S	MCF816SK	MCF816BK
MCF117SP	MCF568L	MCF503R	MCF408L	MCF408R	MCF600L	MCF600R	MCF510	MCF215W	MCF230W								MCF927L	MCF924S	MCF817SK	MCF817BK
MCF118SP	MCF561L	MCF501R	MCF401L	MCF401R	MCF600L	MCF600R	4)	MCF210W	MCF220W	MCF225W	MCF230W						MCF927L	MCF928	MCF818SK	MCF818BK
MCF119SP	MCF573L	MCF506R	MCF416L	MCF416R	MCF600L	MCF600R	MCF521	MCF150W									MCF927L	MCF923S	MCF819SK	MCF819BK
MCF121SP	MCF576L	MCF508R	MCF484L	MCF484R	MCF600L	MCF600R	MCF533	2)									MCF927L	MCF924S	MCF821SK	
MCF124SP	MCF568L	MCF506R	MCF431L	MCF431R	MCF600L	MCF600R	MCF515	MCF160X	MCF140X								MCF927L	MCF923S	MCF824SK	MCF824BK
MCF125SP	MCF573L	MCF505R	MCF437L	MCF437R	MCF600L	MCF600R	MCF509	MCF170W									MCF927L	MCF923S	MCF825SK	
MCF126SP	MCF550L	MCF500R	MCF422L	MCF422R	MCF610L	MCF600R	MCF505	2)									MCF927L	MCF923S	MCF826SK	
MCF127SP	MCF581L	MCF553R	MCF432L	MCF432R	MCF600L	MCF600R	MCF504	2)									MCF927L	MCF923S	MCF827SK	MCF827BK
MCF127SP-UM	MCF581L	MCF553R	MCF432L	MCF432R	MCF600L	MCF600R	MCF504	2)									MCF927L	MCF923S	MCF127SK	MCF127BK
MCF128SP	MCF568L	MCF505R	MCF403L	MCF403R	MCF600L	MCF600R	MCF509	MCF240Y	MCF255Y								MCF927L	MCF923S	MCF828SK	
MCF128SP	MCF551L	MCF500R	MCF129L	MCF129R	MCF610L	MCF630R	MCF506										MCF927L	MCF923S		
MCF133SP	MCF568L	MCF507R	MCF435L	MCF435R	MCF600L	MCF600R	MCF513	MCF220X	MCF240Y								MCF927L	MCF924S	MCF833SK	
MCF134SP	MCF586L	MCF517R	MCF445L	MCF445R	MCF600L	MCF600R	MCF544	2)									MCF927L	MCF923S	MCF834SK	MCF834BK
MCF135SP	MCF576L	MCF508R	MCF484L	MCF484R	MCF600L	MCF600R	MCF533	MCF420									MCF927L	MCF924S	MCF835SK	MCF835BK
MCF136SP	MCF554L	MCF503R	MCF455L	MCF455R	MCF600L	MCF600R	MCF510	MCF185Y	MCF205Y								MCF928	MCF924S		
MCF141SP	MCF577L	MCF506R	MCF442L	MCF442R	MCF600L	MCF600R	MCF515	2)									MCF927L	MCF923S	MCF841SK	MCF841BK
MCF142SP	MCF568L	MCF516R	MCF441L	MCF441R	MCF600L	MCF620R	MCF518	MCF195Y									MCF927L	MCF924S	MCF842SK	MCF842BK
MCF143SP	MCF584L	MCF588R	MCF451L	MCF451R	MCF600L	MCF600R	MCF518	MCF120W	MCF140W								MCF927L	MCF923S	MCF843SK	
MCF145SP	MCF568L	MCF506R	MCF419L	MCF419R	MCF600L	MCF600R	MCF536	MCF250X	MCF265X								MCF927L	MCF924S	MCF845SK	MCF845BK
MCF150SP	MCF454S	MCF507R	MCF493L	MCF493R	MCF600L	MCF600R	MCF538	MCF245W									MCF928	MCF923S	MCF850SK	
MCF153SP	MCF587L	MCF503R	MCF492L	MCF492R	MCF600L	MCF600R	MCF500	MCF265X	MCF290X								MCF928	MCF924S	MCF853SK	MCF853BK
MCF155SP	MCF552L	MCF506S	MCF452L	MCF452R	MCF600L	MCF600R	MCF523										MCF927L	MCF923S	MCF855SK	MCF855BK
MCF161SP	MCF575L	MCF517R	MCF438L	MCF438R	MCF600L	MCF600R	MCF540	MCF130W									MCF927L	MCF923S	MCF861SK	MCF861BK
MCF162SP	MCF575L	MCF509R	MCF404L	MCF404R	MCF600L	MCF600R	MCF524	2)									MCF927L	MCF923S	MCF862SK	
MCF163SP	MCF568L	MCF506R	MCF417L	MCF417R	MCF600L	MCF600R	MCF511	MCF165X	MCF185X	MCF200X							MCF927L	MCF923S	MCF863SK	MCF863BK
MCF164SP	MCF565L	MCF505R	MCF409L	MCF409R	MCF600L	MCF600R	MCF527	MCF240VG	MCF255VG								MCF928	MCF924S	MCF864SK	MCF864BK
MCF166SP	MCF568L	MCF506R	MCF411L	MCF411R	MCF600L	MCF600R	MCF529	MCF205X									MCF927L	MCF923S	MCF866SK	MCF866BK
MCF168SP	MCF565L	MCF554R	MCF424L	MCF424R	MCF600L	MCF600R	MCF537	MCF305W	MCF320W								MCF928	1)	MCF868SK	MCF868BK
MCF168SP	MCF571L	MCF507R	MCF482L	MCF482R	MCF600L	MCF600R	MCF519	MCF215W									MCF927L	MCF923S	MCF869SK	MCF869BK
MCF170SP	MCF585L	MCF517R	MCF420L	MCF420R	MCF600L	MCF600R	MCF541	2)									MCF927L	MCF924S	MCF870SK	
MCF171SP	MCF468S	MCF503R	MCF485L	MCF485R	MCF600L	MCF600R	MCF500	MCF110W	MCF085W								MCF927L	MCF924S	MCF871SK	MCF871BK
MCF172SP	MCF568L	MCF503R	MCF427L	MCF427R	MCF600L	MCF600R	MCF517	MCF180Y									MCF927L	MCF924S	MCF872SK	MCF872BK
MCF173SP	MCF568L	MCF535R	MCF428L	MCF428R	MCF600L	MCF600R	MCF534	MCF230W									MCF927L	1)	MCF873SK	MCF873BK
MCF174SP	MCF584L	MCF535R	MCF446L	MCF446R	MCF600L	MCF600R	MCF534	MCF220W	MCF095W								MCF927L	1)	MCF874SK	MCF874BK
MCF179SP	MCF567L	MCF507R	MCF448L	MCF448R	MCF600L	MCF600R	MCF502	MCF130W	MCF120W								MCF927L	MCF923S	MCF879SK	MCF879BK
MCF180SP	MCF583L	MCF553R	MCF447L	MCF447R	MCF600L	MCF600R	MCF503	MCF145W	MCF120W								MCF927L	MCF923S	MCF880SK	MCF880BK
MCF181SP	MCF568L	MCF506R	MCF415L	MCF415R	MCF600L	MCF600R	MCF529	MCF240X	MCF255X								MCF927L	MCF923S	MCF881SK	MCF881BK
MCF182SP	MCF568L	MCF506R	MCF415L	MCF415R	MCF600L	MCF600R	MCF529	MCF150X	MCF170X								MCF927L	MCF923S	MCF881SK	MCF881BK
MCF183SP	MCF568L	MCF506R	MCF481L	MCF481R	MCF600L	MCF600R	MCF515	MCF185X	MCF205X											

MCF188SP	MCF566L	MCF506R	MCF483L	MCF483R	MCF600L	MCF600R	MCF515	MCF160X	MCF180X	MCF185V		MCF927L	MCF923S	MCF886SK	MCF886BK
MCF187SP	MCF562L	MCF506R	MCF487L	MCF487R	MCF600L	MCF600R	MCF511	2)				MCF927L	MCF923S	MCF887SK	MCF887BK
MCF188SP	MCF562L	MCF506R	MCF412L	MCF412R	MCF600L	MCF600R	MCF515	2)				MCF927L	MCF923S	MCF888SK	MCF888BK
MCF189SP	MCF562L	MCF506R	MCF418L	MCF418R	MCF600L	MCF600R	MCF515	2)				MCF927L	MCF923S	MCF889SK	
MCF190SP	MCF507R	MCF507R	MCF433L	MCF433R	MCF600L	MCF600R	MCF513	MCF220X				MCF928	MCF924S	MCF890SK	MCF890BK
MCF190SP-UM	MCF570L	MCF507R	MCF433L	MCF433R	MCF600L	MCF600R	MCF513	MCF200X	MCF120W			MCF927L	MCF924S	MCF892SK	MCF892BK
MCF191SP	MCF568L	MCF507R	MCF413L	MCF413R	MCF600L	MCF600R	MCF531	MCF200W	MCF191SP			MCF927L	MCF923S	MCF891SK	MCF891BK
MCF192SP	MCF565L	MCF555R	MCL453L	MCL453R	MCF600L	MCF600R	MCF513					MCF928	MCF924S	MCF192SK	
MCF193SP	MCF568L	MCF535R	MCF423L	MCF423R	MCF600L	MCF600R	MCF533	MCF130W	MCF140W			MCF927L	1)	MCF893SK	MCF893BK
MCF194SP	MCF565L	MCF505R	MCF494L	MCF494R	MCF600L	MCF600R	MCF509	MCF210W	MCF225W			MCF928	MCF923S	MCF894SK	MCF894BK
MCF195SP	MCF564L	MCF505R	MCF495L	MCF495R	MCF600L	MCF600R	MCF509	MCF160W				MCF927L	MCF923S	MCF895SK	MCF895BK
MCF196SP	MCF566L	MCF506R	MCF496L	MCF496R	MCF600L	MCF600R	MCF515	MCF220X				MCF927L	MCF923S	MCF896SK	
MCF197SP	MCF565L	MCF507R	MCF497L	MCF497R	MCF600L	MCF600R	MCF513	MCF225W	MCF240W			MCF928	MCF924S	MCF897SK	MCF897BK
MCF197SP-UM	MCF570L	MCF507R	MCF497L	MCF497R	MCF600L	MCF600R	MCF513	MCF170W				MCF927L	MCF924S	MCF197SK	
MCF198SP	MCF568L	MCF503R	MCF498L	MCF498R	MCF600L	MCF600R	MCF510	MCF200W	MCF210W			MCF927L	MCF924S	MCF898SK	MCF898BK
MCF199SP	MCF569L	MCF509R	MCF499L	MCF499R	MCF600L	MCF600R	MCF514	MCF170W				MCF927L	MCF924S	MCF899SK	MCF899BK

- 1) Konstruktionsbedingt kein Fersenschutz montierbar
- 2) Verwendung der originalen Schaltstange
- 3) Einteilige Konstruktion von Adapterplatte, Grundplatte und Halter für Bremszylinder
- 4) Bremszylinder nicht an Fußrastenanlage montiert

- 1) due to the design, no heel guard can be installed
- 2) use the original shifting rod
- 3) one-part design of the adapter plate, baseplate and bracket for the brake cylinder
- 4) brake cylinder not installed on the footrest system

Adapterplatten mit ABE Adapter plates, TÜV approved

ADAPTERPLATTEN ZUR VERLEGUNG VON ORIGINAL FUSSRASTENANLAGEN

- hochfeste Aluminiumprodukte aus CNC-Fertigung
- variable Rastenposition für komfortable Sitzposition
- mehr Bodenfreiheit durch geänderte Fußrastenposition
- bei einigen Modellen empfiehlt sich der Austausch des Bremslichtschalters, siehe Seite 5.11
- je nach Modell sind die Adapterplatten silber oder schwarz
- bei Fahrzeugen, die im OE bereits mit einer Adapterplatte ausgerüstet sind, ersetzt die TRW Adapterplatte das OE Teil und verfügt über einen größeren Verstellbereich

ADAPTER PLATES FOR ADJUSTING ORIGINAL FOOTREST ASSEMBLIES

- highly stable CNC manufactured aluminium products
- variable positions to make riding more comfortable
- raises the footrest position for greater ground clearance
- for some models, we recommend replacing the brakelight switch, see page 5.11
- depending on the model, the adapter plates are silver or black
- for vehicles which are already equipped with an adapter plate in the OE, the TRW adapter plate replaces the OE part offering a larger adjustment range



VERLEGEMÖGLICHKEITEN FÜR ORIGINALANLAGEN:

- ➔ 26 mm - 46 mm
- ⬆ max. 25 mm
- ⬇ max. 10 mm

MAKES ORIGINAL SETS ADJUSTABLE:

- ➔ 26 mm - 46 mm
- ⬆ max. 25 mm
- ⬇ max. 10 mm

								Farbe Colour	
Aprilia									
RSV	1000	Mille	ME	98-00	MCF 706-L	MCF 706-R	=====		
RSV	1000	Mille	RP	01-03	MCF 706-L	MCF 706-R	=====		
RSV	1000	Mille R	RP	01-03	MCF 706-L	MCF 706-R	=====		
RSV	1000	Mille SP	RP	01-03	MCF 706-L	MCF 706-R	=====		
RSV	1000	R, Tuono	RR	04-08	MCF 707-L	MCF 707-R	=====		
Honda									
CBR	600	F	PC35	99-07	MCF 728-L	MCF 728-R	=====		
CBR	600	RR	PC37	03-06	MCF 794-L	MCF 794-R	=====		
CBR	600	RR	PC40	07-08	MCF 794-L	MCF 794-R	=====		2)
CBR	600	RR	PC40	09-16	MCF 794-L	MCF 794-R	=====		2)
CBR	900	RR	SC28	92-93	MCF 721-L	MCF 721-R	=====		
CBR	900	RR	SC28	94-95	MCF 721-L	MCF 721-R	=====		
CBR	900	RR	SC33	96-97	MCF 721-L	MCF 721-R	=====		
CBR	900	RR	SC33	98-99	MCF 721-L	MCF 721-R	=====		
CBR	900	RR	SC44	00-01	MCF 791-L	MCF 791-R	=====		
CBR	1000	RR	SC57	04-07	MCF 794-L	MCF 794-R	=====		2)
VTR	1000	SP1	RC51	00-02	MCF 792-L	MCF 792-R	=====		
Kawasaki									
ZX-6R	600	Ninja	ZX600F	94-97	MCF 730-L	MCF 730-R	=====		
ZX-6R	600	Ninja	ZX600G/H	98-02	MCF 738-L	MCF 738-R	=====		
ZX-6R	600	RR	ZX600K	03-04	MCF 777-L	MCF 777-R	=====		
ZX-6R	600	RR	ZX600N	05-06	MCF 771-L	MCF 771-R	=====		
ZX-6R	600	Ninja	ZX600P	07-08	MCF 795-L	MCF 795-R	=====		
ZX-6R	600	Ninja	ZX600R	09-16	MCF 795-L	MCF 795-R	=====		2)
ZX-6R	636	Ninja	ZX636A	02	MCF 738-L	MCF 738-R	=====		
ZX-6R	636	Ninja	ZX600B	03-04	MCF 777-L	MCF 777-R	=====		
ZX-6R	636	Ninja	ZX600C	05-06	MCF 771-L	MCF 771-R	=====		
ZX-7R	750	Ninja	ZX750N	96-00	MCF 730-L	MCF 730-R	=====		
ZX-7R	750	Ninja	ZX750P	96-00	MCF 730-L	MCF 730-R	=====		
Z	750		ZR750L	07-14	MCF 739-L	MCF 739-R	=====		6)
ZXR	750		ZX750J	91-95	MCF 730-L	MCF 730-R	=====		
ZXR	750	R	ZX750L	91-95	MCF 730-L	MCF 730-R	=====		
ZXR	750	R	ZX750K	91-92	MCF 730-L	MCF 730-R	=====		

							Farbe Colour	
ZXR	750	R	ZX750M	93-95	MCF 730-L	MCF 730-R	=====	
ZX-9R	900	Ninja	ZX900B	93-97	MCF 730-L	MCF 730-R	=====	
ZX-9R	900	Ninja	ZX900C	98	MCF 738-L	MCF 738-R	=====	
ZX-9R	900	Ninja	ZX900D	98-99	MCF 738-L	MCF 738-R	=====	
ZX-9R	900	Ninja	ZX900E	00-03	MCF 738-L	MCF 738-R	=====	
Z	1000		ZRT00E	07-09	MCF 739-L	MCF 739-R	=====	6)
ZX-10R	1000	Ninja	ZXT00C	04-05	MCF 779-L	MCF 779-R	=====	7)
ZX-10R	1000	Ninja	ZXT00D	06-07	MCF 778-L	MCF 778-R	=====	
ZX-10R	1000	Ninja	ZXT00E	08-10	MCF 717-L	MCF 717-R	=====	
Suzuki								
GSF	600	Bandit	GN77B	94-99	MCF 745-L	MCF 745-R	=====	3)
GSF	600	Bandit	WVA8	00-04	MCF 745-L	MCF 745-R	=====	3)
GSF	650	Bandit	WVB5	05-06	MCF 745-L	MCF 745-R	=====	4)
GSF	650	Bandit	WVCJ	07-09	MCF 746-L	MCF 746-R	=====	
GSX-R	600		AD311	96-00	MCF 741-L	MCF 741-R	=====	
GSX-R	600		WVBG	01-03	MCF 741-L	MCF 741-R	=====	
GSX-R	600		WVB2	04-05	MCF 741-L	MCF 741-R	=====	
GSX-R	600		WVCE	06-07	MCF 787-L	MCF 787-R	=====	1)
GSX-R	600		WVCV	08-10	MCF 787-L	MCF 787-R	=====	1)
GSX-R	600		C3	11-16	MCF 708-L	MCF 708-R	=====	1)
SV	650		AV111	99-02	MCF 741-L	MCF 741-R	=====	3)
SV	650		WVBY	03-10	MCF 741-L	MCF 741-R	=====	
GSX-R	750	W	GR7DB	96-99	MCF 741-L	MCF 741-R	=====	
GSX-R	750	W	WVBD	00-03	MCF 741-L	MCF 741-R	=====	
GSX-R	750		WVB3	04-05	MCF 741-L	MCF 741-R	=====	
GSX-R	750		WVCF	06-07	MCF 787-L	MCF 787-R	=====	1)
GSX-R	750		WVCW	08-10	MCF 787-L	MCF 787-R	=====	1)
GSX-R	750		C4	11-16	MCF 708-L	MCF 708-R	=====	1)
GSX-R	1000		WVBL	01-02	MCF 741-L	MCF 741-R	=====	
GSX-R	1000		WVBZ	03-04	MCF 741-L	MCF 741-R	=====	
GSX-R	1000		WVB6	05-06	MCF 786-L	MCF 786-R	=====	
GSX-R	1000		WVCL	07-08	MCF 796-L	MCF 796-R	=====	
GSX-R	1000		WVCY	09-16	MCF 797-L	MCF 797-R	=====	
SV	1000		WVBX	03-08	MCF 741-L	MCF 741-R	=====	
GSX-R	1100	W	GU75C	93-97	MCF 743-L	MCF 743-R	=====	
GSF	1200	Bandit	GV75A	96-00	MCF 745-L	MCF 745-R	=====	3)
GSF	1200	Bandit	WVA9	01-05	MCF 745-L	MCF 745-R	=====	3)
GSF	1200	Bandit	WVCB	06	MCF 745-L	MCF 745-R	=====	4)
GSF	1250	Bandit	WVCH	07-17	MCF 746-L	MCF 746-R	=====	
Triumph								
	900	Speed Triple	T509	97-99	MCF 760-L	MCF 760-R	=====	
	950	Daytona	T595	97-98	MCF 760-L	MCF 760-R	=====	
	955	Daytona i	T595	96-01	MCF 760-L	MCF 760-R	=====	
	955	Speed Triple	595NPC	00-04	MCF 760-L	MCF 760-R	=====	
Yamaha								
YZF	600	R6	RJ05	03	MCF 767-L	MCF 767-R	=====	5)
YZF	600	R6	RJ09	04-05	MCF 767-L	MCF 767-R	=====	5)

- 1) vier Lochreihen
- 2) Hitzeblech entfällt
- 3) hydraulischer Stoplichtschalter MCF 935 notwendig
- 4) hydraulischer Stoplichtschalter MCF 936 notwendig
- 5) Schaltung außerhalb des Rahmens
- 6) Modifikation Rahmenblende notwendig
- 7) eingeschränkter Verstellbereich

- 1) four rows of holes
- 2) no heat shield
- 3) hydraulic stoplight switch MCF 935 required
- 4) hydraulic stoplight switch MCF 936 required
- 5) shifting outside the frame
- 6) modification of frame panel required
- 7) limited adjustment range

Lenker Handlebars



ALUMINIUMLENKER ALUMINIUM HANDLEBARS

22 mm Durchmesser **22 mm diameter**

- mit ABE, keine Eintragung nötig
- hochwertige Aluminiumlenker mit eloxierter Oberfläche
- hochfeste Alulegierung
- 5 mm Wandstärke

- with TÜV approval
- high-quality anodised aluminium handlebars
- high strength aluminium alloy
- 5 mm wall thickness

SUPERBIKE – 22 MM



CB und SB sind sandgestrahlt
CB and SB are sand blasted



Bestell-Nr. Order no.	
MCL100 S	
MCL100 C	
MCL100 R	
MCL100 G	
MCL100 T	
MCL100 B	
MCL 100 CB	
MCL 100 SB	

SPEEDFIGHTER – 22 MM



Bestell-Nr. Order no.	
MCL150 S	
MCL150 C	
MCL150 T	
MCL150 B	

**LENKERENDEN »MINI«
HANDLEBAR ENDS »MINI«**



Bestell-Nr. Order no.	
MCL202 C	
MCL203 S	
MCL201 R	
MCL200 B	
MCL204 G	

**LENKERENDEN »CLASSIC«
HANDLEBAR ENDS »CLASSIC«**



Bestell-Nr. Order no.	
MCL212-C	
MCL212-S	
MCL212-B	
MCL212-G	
MCL212-R	
MCL212-T	

Bestell-Nr. Order no.			A	B	C	D	E	F	Ø	Typ		
MCL100 B		Superbike	MCL200 B	MCL212-B	750	53	219	110	145	91	22	0365
MCL100 R		Superbike	MCL201 R	MCL212-R	750	53	219	110	145	91	22	0365
MCL100 C		Superbike	MCL202 C	MCL212-C	750	53	219	110	145	91	22	0365
MCL100 CB		Superbike	MCL202 C	MCL212-C	750	53	219	110	145	91	22	0365
MCL100 S		Superbike	MCL203 S	MCL212-S	750	53	219	110	145	91	22	0365
MCL100 SB		Superbike	MCL203 S	MCL212-S	750	53	219	110	145	91	22	0365
MCL100 G		Superbike	MCL204 G	MCL212-G	750	53	219	110	145	91	22	0365
MCL100 T		Superbike	MCL203 S	MCL212-T	750	53	219	110	145	91	22	0365
MCL150 B		Speedfighter	MCL200 B	MCL212-B	861	47	240	79	153	67	22	0366
MCL150 C		Speedfighter	MCL202 C	MCL212-C	861	47	240	79	153	67	22	0366
MCL150 T		Speedfighter	MCL203 S	MCL212-T	861	47	240	79	153	67	22	0366
MCL150 S		Speedfighter	MCL203 S	MCL212-S	861	47	240	79	153	67	22	0366

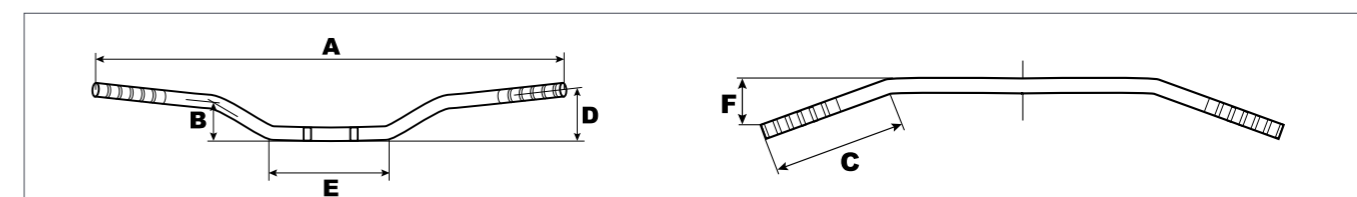

OFFROAD – 22 MM

- hochwertige Aluminiumlenker mit eloxierter Oberfläche
- hochfeste Alulegierung
- Mittelstrebe vorhanden
- 4 mm Wandstärke

OFFROAD – 22 MM

- high-quality anodised aluminium handlebars
- high strength aluminium alloy
- brace available
- 4 mm wall thickness

Ausführung Model	Bestell-Nr. Order no.
Offroad Low	MCL153 C
	MCL153 T
	MCL153 B
Offroad Medium	MCL154 C
	MCL154 T
	MCL154 B
Offroad High	MCL155 S
	MCL155 C
	MCL155 T
	MCL155 B

AUCH PASSEND FÜR QUADS!
ALSO SUITABLE FOR QUADS!



Bestell-Nr. Order no.						A	B	C	D	E	F	Ø	Typ
MCL153	C	T	B			805	42	217	65	120	68	22	0367
MCL154	C	T	B			799	55	208	79	154	61	22	0368
MCL155	C	T	B	S		797	74	198	128	167	81	22	0369

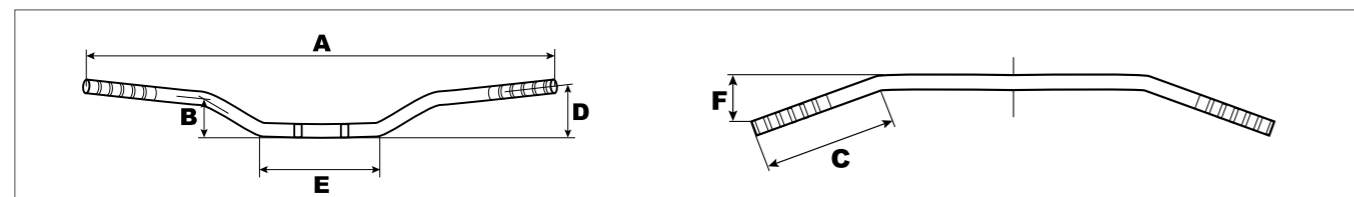

28,6 mm Durchmesser 28.6 mm diameter

- mit ABE, keine Eintragung nötig
- hochwertige Aluminiumlenker mit eloxierter Oberfläche
- hochfeste Alulegierung
- 4 mm Wandstärke, sandgestrahlt

- with TÜV approval
- high-quality anodised aluminium handlebars
- high strength aluminium alloy
- 4 mm wall thickness, sand blasted

SUPERBIKE – 28,6 MM



Bestell-Nr. Order no.	
MCL800 TB	
MCL800 SB	
MCL800 CB	

SPEEDFIGHTER – 28,6 MM



Bestell-Nr. Order no.	
MCL850 SB	

OFFROAD – 28,6 MM



Ausführung Model	Bestell-Nr. Order no.
Offroad Low	MCL853 CB
	MCL853 SB
Offroad Medium	MCL854 CB
	MCL854 SB
Offroad High	MCL855 CB
	MCL855 SB

Bestell-Nr. Order no.					A	B	C	D	E	F	Ø
MCL800	CB	TB	SB	Superbike	750	53	214	110	142	91	28,6
MCL850			SB	Speedfighter	861	47	238	79	179	67	28,6
MCL853	CB		SB	Offroad Low	805	42	217	65	120	68	28,6
MCL854	CB		SB	Offroad Medium	800	56	206	79	153	62	28,6
MCL855	CB		SB	Offroad High	797	74	202	128	167	81	28,6

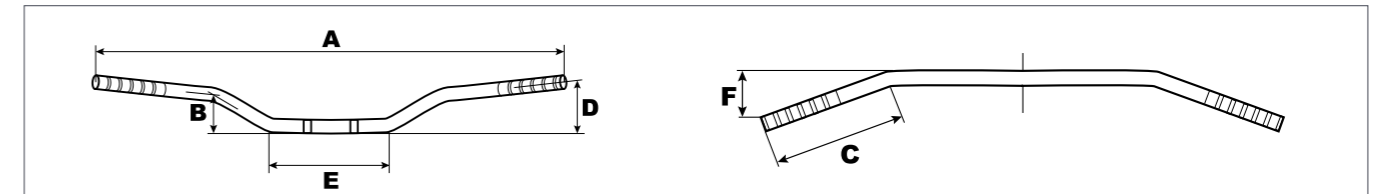

ADAPTER-SET – 35 MM

- für 28,6-mm-Lenker (2 St.)

ADAPTER SET – 35 MM

- for 28.6-mm-handlebar (2 pc.)

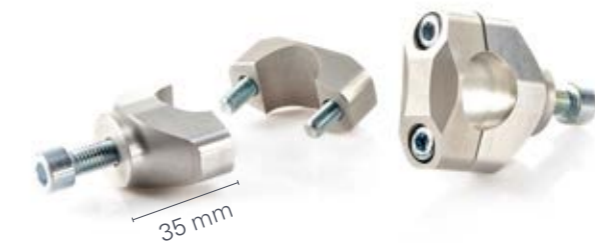

Bestell-Nr. Order no.	
MCL635 C	
MCL635 S	

ADAPTER-SET – 45 MM

- für 28,6-mm-Lenker (2 St.)

ADAPTER SET – 45 MM

- for 28.6-mm-handlebar (2 pc.)



Bestell-Nr. Order no.	
MCL645 C	
MCL645 S	

ADAPTER

- für 28,6-mm-Lenker zur Montage an 22-mm-Lenker-aufnahmen (2 St.)

ADAPTER

- for 28.6-mm-handlebar for installation on 22-mm-handlebar clamps (2 pc.)



Bestell-Nr. Order no.	
MCL622 C	
MCL622 S	





Montagebeispiel: Lenker MCL850 SB + Adapter MCL622 S | Installation example: Handlebar MCL850 SB + adapter MCL622 S

STAHLLENKER 22 MM STEEL HANDLEBARS 22 MM



- mit ABE für viele Fahrzeuge
 - hochwertige Stahllenkertypen »made in Germany«
 - keine Eintragung vom TÜV notwendig
 - 3-faches Beschichtungsverfahren verhindert Korrosion
 - die attraktive Formgebung ermöglicht individuelle Optik
 - große Auswahl an verschiedenen »Superbike« Lenkertypen
 - um die Armatur zu arretieren, kann eine Bohrung angebracht werden
- with ABE for many types of vehicle
 - high-quality, »made in Germany« steel handlebar
 - TÜV registration not required
 - 3-part coating procedure prevents corrosion
 - attractive shape enables individual optics
 - wide selection of different »Superbike« handlebar types
 - a hole can be made to lock the fitting





DREI OBERFLÄCHEN ZUR AUSWAHL!	 SC verchromt chrome plated
THREE SURFACES TO CHOOSE FROM!	 SA Alu-Look aluminium look
	 SS schwarz black

SUPERBIKE – 22 MM





Ausführung Model	Bestell-Nr. Order no.
Speedfighter	MCL124 SC 
	MCL124 SA 
	MCL124 SS 





Ausführung Model	Bestell-Nr. Order no.
Superbike Comfort	MCL126 SC 
	MCL126 SA 
	MCL126 SS 



Ausführung Model	Bestell-Nr. Order no.
Superbike Elegance	MCL127 SC 
	MCL127 SA 
	MCL127 SS 







Ausführung Model	Bestell-Nr. Order no.
Superbike Sportive	MCL128 SC 
	MCL128 SA 
	MCL128 SS 

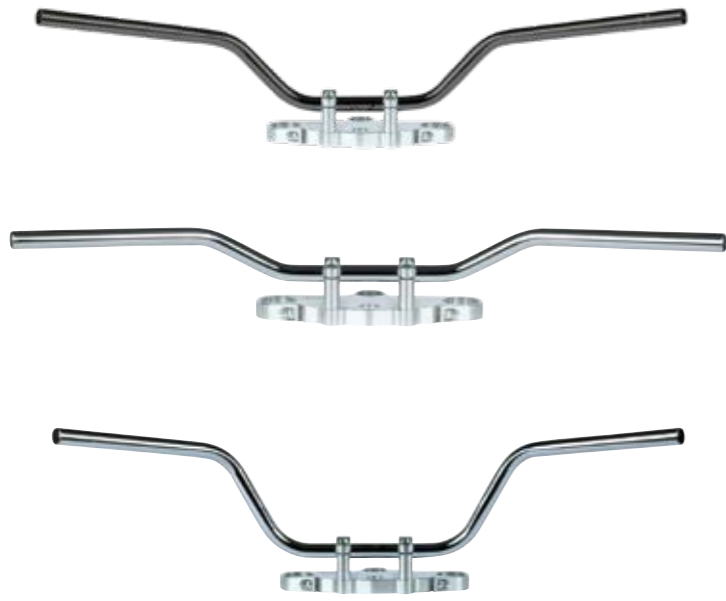



TOURING – 22 MM







Ausführung Model	Bestell-Nr. Order no.
Classic High	MCL110 SC 
	MCL110 SS 

Ausführung Model	Bestell-Nr. Order no.
Classic Low	MCL111 SC 
	MCL111 SS 

Ausführung Model	Bestell-Nr. Order no.
Touring Low	MCL112 SC 
Touring High	MCL113 SC 
	MCL113 SS 



CUSTOM – 22 MM













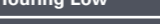

Ausführung Model	Bestell-Nr. Order no.
Dragbar Long	MCL121 SC 
	MCL121 SS 
Dragbar Medium	MCL122 SC 
	MCL122 SS 

Ausführung Model	Bestell-Nr. Order no.
Mystic High	MCL130 SC 

Ausführung Model	Bestell-Nr. Order no.
Roadstar Wide	MCL134 SC 

Ausführung Model	Bestell-Nr. Order no.
Apehanger	MCL137 SC 
	MCL137 SS 

Bestell-Nr. Order no.					A	B	C	D	E	F	Typ
MCL110	SC	SS			810	83	240	83	130	223	01
MCL111	SC	SS			765	44	205	44	170	115	02
MCL112	SC				770	126,4	220	126,4	170	224	03
MCL113	SC	SS			770	132	215	132	170	165	04
MCL121	SC	SS			895	0	290	0	346	149	05
MCL122	SC	SS			800	0	240	0	336	113	06
MCL124	SC	SS	SA		860	42	240	42	170	103	08
MCL126	SC	SS	SA		720	58	200	58	140	165	09
MCL127	SC	SS	SA		755	42	220	42	130	140	10
MCL128	SC	SS	SA		760	31	205	31	140	94	11
MCL130	SC	SS			905	130	240	130	240	191	12
MCL134	SC				960	46	295	46	190	236	14
MCL137	SC	SS			830	226	190	226	180	137	16

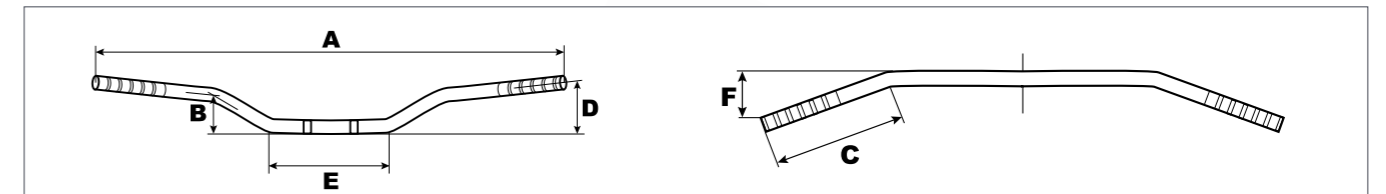

LENKERENDEN

• 2 Stück

Bestell-Nr. | Order no.

MCL217 SC 

MCL217 SA 

MCL217 SS 

HANDLEBAR ENDS

• 2 pieces



STAHLLENKER 1 ZOLL (25,4 MM) STEEL HANDLEBARS 1 INCH

- mit ABE, keine Eintragung nötig
- attraktives Design für stilgerechte Optik
- gutes Lenkverhalten durch ausgereifte Formen
- individuelles Outfit beginnt schon beim Lenkerumbau
- Lenkerwechsel ermöglicht bequemere Sitzposition
- hochwertigste Oberflächenbehandlungen
- 3-fach-Spezialbeschichtung verhindert Korrosion
- keine matten Chromstellen an den Biegepunkten
- Stahlrohre von hoher Güte

- with TÜV approval
- attractive design adds style
- good steering response through fully-developed design
- customising begins with the handlebars
- changing the handlebar allows a more comfortable sitting position
- top quality surface treatments
- triple special coating prevents corrosion
- no matt chrome on the bends
- high quality steel tubes



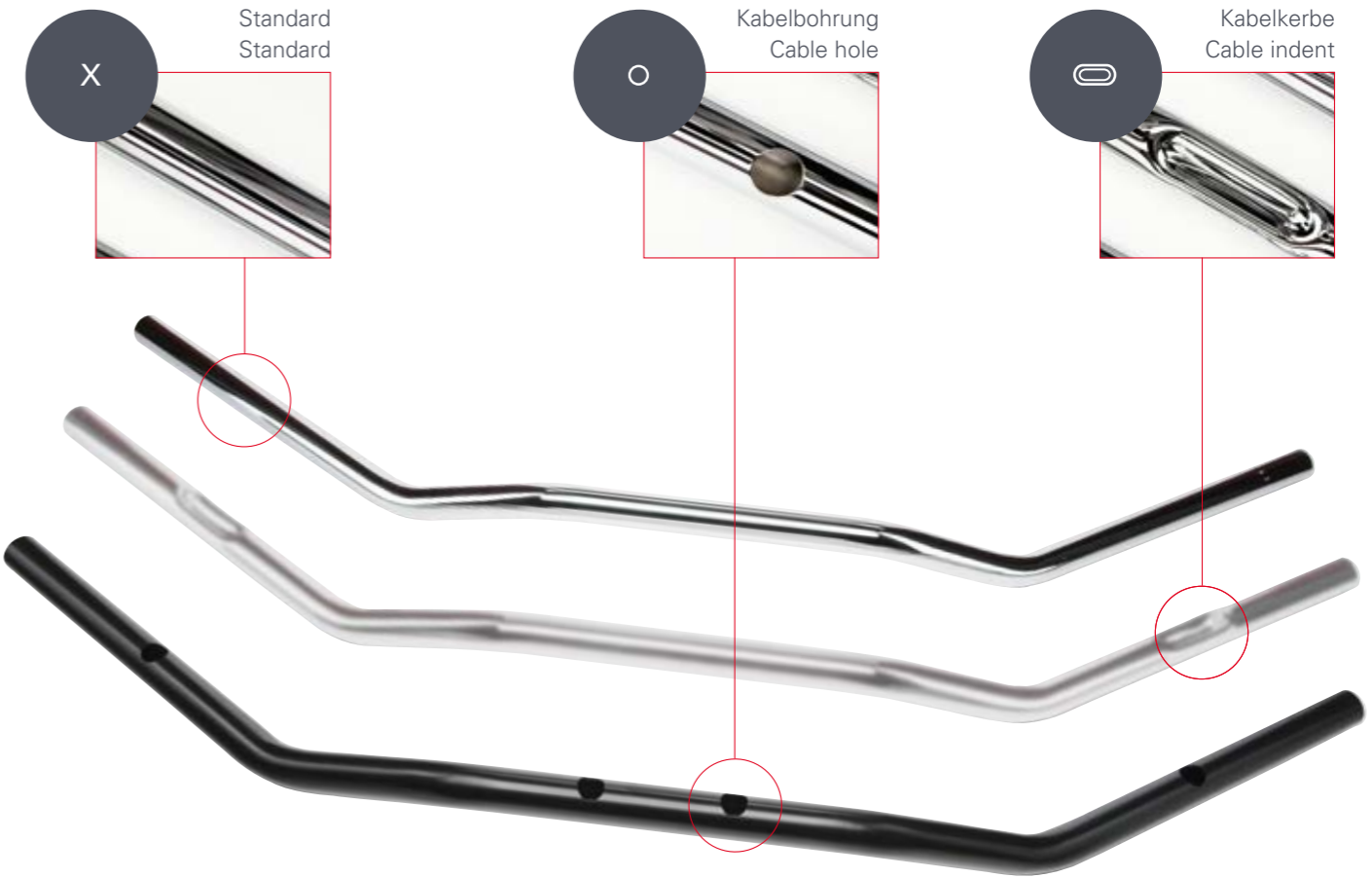

DREI STYLES, DREI FARBEN THREE STYLES, THREE COLOURS



ACHTUNG:
Bitte gewünschte Farbe ergänzen.

CAUTION!
Please indicate required colour.

ÜBERSICHT KOMBINATIONEN OVERVIEW COMBINATIONS

Style			
X	SC Stahl, verchromt steel, chrome plated	SA Stahl, Alu-Look steel, aluminium look	SS Stahl, schwarz black steel
	CKK Stahl, verchromt mit Kabelkerben steel, chrome plated with cable indent	AKK Alu-Look mit Kabelkerben aluminium look with cable indent	SKK schwarz mit Kabelkerben black with cable indent
O	CKB Stahl, verchromt mit Kabelbohrungen steel, chrome plated with cable holes	-	-



Style	X			X		
Dragbar Long MCL120...	SC	CKK	CKB	SS	SKK	
Dragbar Medium MCL123...	SC	CKK		SS	SKK	



Style	X			X			X		
Speedfighter MCL125...	SC	CKK		SA	AKK		SS	SKK	



Style	X			X		
Mystic MCL131...	SC	CKK		SS	SKK	



Style	X			X		
Flyerbar MCL132...	SC	CKK	CKB	SS	SKK	



Style	X			X		
Roadstar Wide MCL133...	SC	CKK		SS	SKK	



Style	X			X		
Roadstar Medium MCL135...	SC	CKK		SS	SKK	



Style	X			X		
Apehanger MCL136...	SC	CKK		SS	SKK	

Bestell-Nr. Order no.		Style						A	B	C	D	E	F	Typ
MCL120	Dragbar Long	SC	SS		CKK	SKK	CKB	900	0	290	0	300	182	05
MCL123	Dragbar Medium	SC	SS		CKK	SKK		795	0	235	0	290	132	06
MCL125	Speedfighter	SC	SS	SA	CKK	SKK	AKK	860	42	240	42	170	106	08
MCL131	Mystic	SC	SS		CKK	SKK		905	140	220	140	240	178	12
MCL132	Flyerbar	SC	SS		CKK	SKK	CKB	970	42	270	42	200	180	13
MCL133	Roadstar Wide	SC	SS		CKK	SKK		965	49	290	49	190	238	14
MCL135	Roadstar Medium	SC	SS		CKK	SKK		900	86	280	86	190	306	15
MCL136	Apehanger	SC	SS		CKK	SKK		920	220	235	220	170	147	16

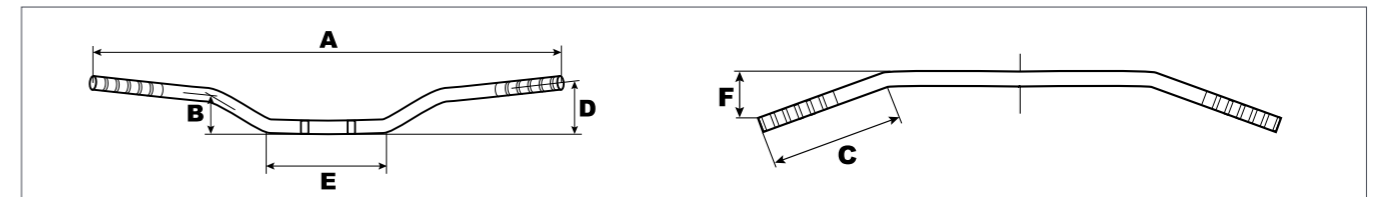

STUMMELLENKER CLIP-ONS

Racing Stummel

- mit TÜV Gutachten
- hightech Produkt »made in Germany«
- hochwertiger Aluminiumlenker für den sportlichen Einsatz
- Höhe der Klemmschelle 32 mm
- Winkel der Lenkrohr-Kröpfung = 5,5°
- extrem leichtgewichtig mit nur 660 g
- schwarz eloxiert
- Set inkl. Lenkrohre (250 mm lang) und Lenkerstopfen
- Klemmschelle mit 45, 50, 53 und 55 mm Durchmesser

Racing clip-ons

- with TÜV approval
- hightech Product »made in Germany«
- high-grade aluminium handle bars for sportive riding
- height of the clamp 32 mm
- angle of the handle bar tube offset = 5.5°
- extremely lightweight at only 660 g
- anodised in black
- set incl. handlebar tubes (250 mm long) and handlebar plugs
- 45, 50, 53 and 55 mm clamp diameter options

**LIEFERUNG
ALS SET!
DELIVERY
AS A SET!**



Ø	Bestell-Nr. Order no.
45 mm	MCL45 EC
50 mm	MCL50 EC
53 mm	MCL53 EC
55 mm	MCL55 EC

5,5° Kröpfung | 5.5° offset

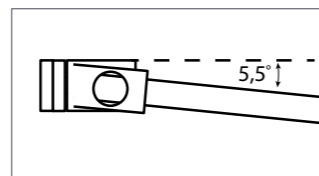

HINWEIS!

Bei anderen Gabeldurchmessern Distanzhülsen verwenden (S. 5.34).

REMARK!

Use spacers for other fork diameters (p. 5.34).

Racing SP – Heavy Duty Racing-Stummel

- Hightech Produkt »made in Germany«
- besonders stabile Konstruktion, dennoch leichter als die meisten Originallenker
- einfacher Wechsel der Lenkrohre, z.B. nach einem Sturz
- attraktives Finish, schwarz eloxiert
- Set inkl. Lenkrohre (250 mm lang) und Lenkerstopfen
- Klemmschellendurchmesser 45, 50, 53 und 55 mm
- längere Lenkrohre (285 mm) in mehreren Farben optional erhältlich

Racing SP – Heavy duty racing clip-ons

- high tech product »made in Germany«
- particularly robust design, yet still lighter than most original handlebars
- easy replacement of handlebar tubes, e.g. after a crash
- attractive finish, black anodised
- set incl. handlebar tubes (250 mm long) and handlebar plugs
- clamp diameter 45, 50, 53 and 55 mm
- longer handlebars (285 mm) optionally available in several colours

**LIEFERUNG
ALS SET!
DELIVERY
AS A SET!**



Ø	Bestell-Nr. Order no.
45 mm	MCL45 RAC-S
50 mm	MCL50 RAC-S
53 mm	MCL53 RAC-S
55 mm	MCL55 RAC-S

5,5° Kröpfung | 5.5° offset

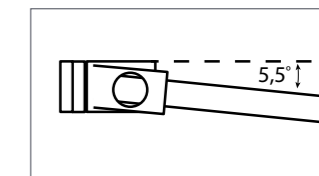

HINWEIS!

Bei anderen Gabeldurchmessern Distanzhülsen verwenden (S. 5.34).

REMARK!

Use spacers for other fork diameters (p. 5.34).

Aprilia							
RSV	1000	Mille	ME	98-00	53	MCL 53 EC	MCL 53 RAC-S
RSV	1000	Mille	RP	01-03	53	MCL 53 EC	MCL 53 RAC-S
RSV	1000	R	RP / ME	01-03	51	MCL 53 EC	MCL 53 RAC-S MCL 51 DH
SL	1000	Falco	PA	00-05	51	MCL 53 EC	MCL 53 RAC-S MCL 51 DH
RSV	1000	R Factory	RR	03-10	51	MCL 53 EC	MCL 53 RAC-S MCL 51 DH
RSV4	1000	Factory	RK	10-12	51	MCL 53 EC	MCL 53 RAC-S MCL 51 DH
RSV4	1000	Factory APRC	RK	11-14	51	MCL 53 EC	MCL 53 RAC-S MCL 51 DH
RSV4	1000	R	RK	10	51	MCL 53 EC	MCL 53 RAC-S MCL 51 DH
RSV4	1000	R APCR	RK	10-15	51	MCL 53 EC	MCL 53 RAC-S MCL 51 DH
RSV4	1000	RF	RK	15-16	51	MCL 53 EC	MCL 53 RAC-S MCL 51 DH
BMW							
HP	1000	RR	K10	13-	55	MCL 55 EC	MCL 55 RAC-S
S	1000	RR	K10	09-15	55	MCL 55 EC	MCL 55 RAC-S
Ducati							
	748	S, SP, SPS	748	95-00	53	MCL 53 EC	MCL 53 RAC-S
	748		H3	99-03	53	MCL 53 EC	MCL 53 RAC-S
	749	R, S	H5	03-07	53	MCL 53 EC	MCL 53 RAC-S
	750	SS	750SC	91-98	50	MCL 50 EC	MCL 50 RAC-S
	750	SS i.E.	V2	99-02	50	MCL 50 EC	MCL 50 RAC-S
	848	, EVO	H6	08-11	53	MCL 53 EC	MCL 53 RAC-S
	888	Strada	888 S	93-96	50	MCL 50 EC	MCL 50 RAC-S
	900	SS	906SC	91-98	50	MCL 50 EC	MCL 50 RAC-S
	900	SS i.E.	V1	98-02	50	MCL 50 EC	MCL 50 RAC-S
	916	Strada, SPO, SP	916S	94-98	53	MCL 53 EC	MCL 53 RAC-S
	916	SPS	916S	97-98	53	MCL 53 EC	MCL 53 RAC-S
	996	SPS	H1	97-01	53	MCL 53 EC	MCL 53 RAC-S
	998	,S	H2	01-04	53	MCL 53 EC	MCL 53 RAC-S
	999	,S,R,Biposto	H4	02-06	53	MCL 53 EC	MCL 53 RAC-S
	1098	,R,S	H7	07-09	53	MCL 53 EC	MCL 53 RAC-S
	1198	,S,SPR	H7	09-11	53	MCL 53 EC	MCL 53 RAC-S
	1199	Panigale R	H8	13-17	53	MCL 53 EC	MCL 53 RAC-S
Honda							
CBR	600	F	PC25	91-94	41	MCL 45 EC	MCL 45 RAC-S MCL 41 DH
CBR	600	F	PC31	95-98	41	MCL 45 EC	MCL 45 RAC-S MCL 41 DH
CBR	600	F	PC35	99-07	43	MCL 45 EC	MCL 45 RAC-S MCL 43 DH
CBR	600	RR	PC37	03-04	45	MCL 45 EC	MCL 45 RAC-S
CBR	600	RR	PC37	05-06	48	MCL 50 EC	MCL 50 RAC-S MCL 48 DH
CBR	600	RR	PC40	07-16	41	MCL 45 EC	MCL 45 RAC-S MCL 41 DH
VFR	800		RC46	98-01	41	MCL 45 EC	MCL 45 RAC-S MCL 41 DH
VFR	800		RC46	02-05	43	MCL 45 EC	MCL 45 RAC-S MCL 43 DH
CBR	900	RR Fireblad	SC28	92-95	45	MCL 45 EC	MCL 45 RAC-S
CBR	900	RR Fireblad	SC33	96-97	45	MCL 45 EC	MCL 45 RAC-S
CBR	900	RR Fireblad	SC44	00-01	50	MCL 50 EC	MCL 50 RAC-S
CBR	900	RR Fireblad	SC50	02-03	50	MCL 50 EC	MCL 50 RAC-S
CBR	1000	Fireblade	SC57	04-07	50	MCL 50 EC	MCL 50 RAC-S
CBR	1000	RR Fireblad	SC59	08-16	50	MCL 50 EC	MCL 50 RAC-S
CBR	1000	RR Fireblad SP	SC59	14-16	53	MCL 53 EC	MCL 53 RAC-S
CBR	1000	F Dual	SC24	93-01	41	MCL 45 EC	MCL 45 RAC-S MCL 41 DH
VTR	1000	Firestorm	SC36	97-08	41	MCL 45 EC	MCL 45 RAC-S MCL 41 DH
VTR	1000	SP1	SC45	00-01	50	MCL 50 EC	MCL 50 RAC-S
VTR	1000	SP2	SC45	02-07	50	MCL 50 EC	MCL 50 RAC-S
CBR	1100	XX Blackbird	SC35	97-08	43	MCL 45 EC	MCL 45 RAC-S MCL 43 DH
Kawasaki							
ZXR	400		ZX400L	91-03	50	MCL 50 EC	MCL 50 RAC-S
ZX-6R	600	Ninja	ZX600F	94-97	41	MCL 45 EC	MCL 45 RAC-S MCL 41 DH
ZX-6R	600	Ninja	ZX600G	98-99	46	MCL 50 EC	MCL 50 RAC-S MCL 46 DH
ZX-6R	600	Ninja	ZX600J	00-02	46	MCL 50 EC	MCL 50 RAC-S MCL 46 DH
ZX-6RR	600	Ninja	ZX600K	03-04	50	MCL 50 EC	MCL 50 RAC-S
ZX-6RR	600	Ninja	ZX600N	05-06	50	MCL 50 EC	MCL 50 RAC-S
ZX-6R	600	Ninja	ZX600P	07-08	50	MCL 50 EC	MCL 50 RAC-S
ZX-6R	600	Ninja	ZX600R	09-16	51	MCL 53 EC	MCL 53 RAC-S MCL 51DH
ZX-6R	636	Ninja	ZX636A	02	46	MCL 50 EC	MCL 50 RAC-S MCL 46 DH
ZX-6R	636	Ninja	ZX636B	03-04	50	MCL 50 EC	MCL 50 RAC-S
ZX-6R	636	Ninja	ZX636C	05-06	50	MCL 50 EC	MCL 50 RAC-S
ZX-7R	750		ZX750P	96-02	52	MCL 53 EC	MCL 53 RAC-S MCL 52 DH
ZXR	750	Ninja	ZX750K/L/M	92-95	52	MCL 53 EC	MCL 53 RAC-S MCL 52 DH
ZX-9R	900	Ninja	ZX900B	94-97	52	MCL 53 EC	MCL 53 RAC-S MCL 52 DH
ZX-9R	900	Ninja	ZX900C	98-00	46	MCL 50 EC	MCL 50 RAC-S MCL 46 DH
ZX-9R	900	Ninja	ZX900E	01-04	46	MCL 50 EC	MCL 50 RAC-S MCL 46 DH
Z	1000		ZRT 00 A	03-06	50	MCL 50 EC	MCL 50 RAC-S
ZX-10R	1000	Ninja	ZXT00C	04-05	50	MCL 50 EC	MCL 50 RAC-S
ZX-10R	1000	Ninja	ZXT00D	06-07	50	MCL 50 EC	MCL 50 RAC-S
ZX-10R	1000	Ninja	ZXT00E	08-09	50	MCL 50 EC	MCL 50 RAC-S
ZX-10R	1000	Ninja	ZXT00F	10-11	50	MCL 50 EC	MCL 50 RAC-S
ZX-10R	1000	Ninja	ZXT00J, K	10-15	50	MCL 50 EC	MCL 50 RAC-S
ZZR	1100		ZXT10D	94-01	43	MCL 45 EC	MCL 45 RAC-S MCL 43 DH
ZZR	1200		ZXT20C	02-05	43	MCL 45 EC	MCL 45 RAC-S MCL 43 DH
ZZR	1400		ZXT40A	06-07	43	MCL 45 EC	MCL 45 RAC-S MCL 43 DH
ZZR	1400		ZXT40C	08-11	43	MCL 45 EC	MCL 45 RAC-S MCL 43 DH

ZZR	1400		ZXT40E	12-15	43	MCL 45 EC	MCL 45 RAC-S MCL 43 DH
KTM							
RC	390			14-	43	MCL 45 EC	MCL 45 RAC-S MCL 43 DH
RC8	1190	R		09-16	43	MCL 45 EC	MCL 45 RAC-S MCL 43 DH
MV Augusta							
F3	675			15	50	MCL 50 EC	MCL 50 RAC-S
F3	800		F310	14-16	50	MCL 50 EC	MCL 50 RAC-S
Suzuki							
RGV	250		VJ22A	91-92	50	MCL 50 EC	MCL 50 RAC-S
GSXR	600		AD	97-00	45	MCL 45 EC	MCL 45 RAC-S
GSXR	600		VVVBG	01-03	45	MCL 45 EC	MCL 45 RAC-S
GSXR	600		VVB2	04-05	50	MCL 50 EC	MCL 50 RAC-S
GSXR	600		VVCE	06-07	50	MCL 50 EC	MCL 50 RAC-S
GSXR	600		VWCV	08-10	50	MCL 50 EC	MCL 50 RAC-S
GSXR	600		C3	11-16	50	MCL 50 EC	MCL 50 RAC-S
SV	650	S	AV111	99-02	41	MCL 45 EC	MCL 45 RAC-S MCL 41 DH
SV	650	S	VVBY	03-09	41	MCL 45 EC	MCL 45 RAC-S MCL 41 DH
GSXR	750		GR7AB	90-91	50	MCL 50 EC	MCL 50 RAC-S
GSXR	750		GR7BB	92-95	50	MCL 50 EC	MCL 50 RAC-S
GSXR	750		GR7DB	96-99	50	MCL 50 EC	MCL 50 RAC-S
GSXR	750		VVBD	00-03	50	MCL 50 EC	MCL 50 RAC-S
GSXR	750		VVB3	04-05	50	MCL 50 EC	MCL 50 RAC-S
GSXR	750		VVCF	06-07	50	MCL 50 EC	MCL 50 RAC-S
GSXR	750		VWCW	08-10	50	MCL 50 EC	MCL 50 RAC-S
GSXR	750		C4	11-16	50	MCL 50 EC	MCL 50 RAC-S
GSXR	750		GR7DB	97-99	50	MCL 50 EC	MCL 50 RAC-S
RF	900	R	GT73B	94-97	43	MCL 45 EC	MCL 45 RAC-S MCL 43 DH
GSXR	1000		VVBL	01-02	50	MCL 50 EC	MCL 50 RAC-S
GSXR	1000		VVBZ	03-04	50	MCL 50 EC	MCL 50 RAC-S
GSXR	1000		VVB6	05-06	50	MCL 50 EC	MCL 50 RAC-S
GSXR	1000		VVCL	07-08	50	MCL 50 EC	MCL 50 RAC-S
GSXR	1000		VWCY	09-16	50	MCL 50 EC	MCL 50 RAC-S
SV	1000	,S,N	VVBX	03-08	50	MCL 50 EC	MCL 50 RAC-S
GSXR	1100		GV73C	90-92	52	MCL 53 EC	MCL 53 RAC-S MCL 52 DH
GSXR	1100	W	GU75C	93-97	50	MCL 50 EC	MCL 50 RAC-S
SV	1000	S	VVBX	03-08	46	MCL 50 EC	MCL 50 RAC-S MCL 46 DH
TL	1000	S	AG111	97-01	50	MCL 50 EC	MCL 50 RAC-S
TL	1000	R	AM321	98-02	50	MCL 50 EC	MCL 50 RAC-S
GSXR	1100	W	GU75C	93-97	50	MCL 50 EC	MCL 50 RAC-S
GSXR	1300	R Hayabusa	VVA1	99-07	50	MCL 50 EC	MCL 50 RAC-S
GSXR	1300	R Hayabusa	VWCK	08-12	50	MCL 50 EC	MCL 50 RAC-S
Triumph							
	600	Daytona	806 LV	03-04	43	MCL 45 EC	MCL 45 RAC-S MCL 43 DH
	600	Speed Four	806LB	02-05	43	MCL 45 EC	MCL 45 RAC-S MCL 43 DH
	650	Daytona	865 LX	05	43	MCL 45 EC	MCL 45 RAC-S MCL 43 DH
	675	Daytona	D67LC	06-12	50	MCL 50 EC	MCL 50 RAC-S
	675	Daytona	H67	12-16	50	MCL 50 EC	MCL 50 RAC-S
	900	Speed Triple	T300B	94-96	43	MCL 45 EC	MCL 45 RAC-S MCL 43 DH
	900	Speed Triple	T509	97-00	43	MCL 45 EC	MCL 45 RAC-S MCL 43 DH
	900	Thrupton	986ME	04-08	41	MCL 45 EC	MCL 45 RAC-S MCL 41 DH
T595	955	Daytona	T595	96-01	45	MCL 45 EC	MCL 45 RAC-S
955 i	955	Daytona	595N	02-04	50	MCL 50 EC	MCL 50 RAC-S
	1000	Daytona	T300	93	43	MCL 45 EC	MCL 45 RAC-S MCL 43 DH
	1200	Daytona	T300,D	93-97	43	MCL 45 EC	MCL 45 RAC-S MCL 43 DH
Yamaha							
FZR	600		3HE	89-93	41	MCL 45 EC	MCL 45 RAC-S MCL 41 DH
FZR	600		3RG	89-93	41	MCL 45 EC	MCL 45 RAC-S MCL 41 DH
FZR	600		3RH	89-93	41	MCL 45 EC	MCL 45 RAC-S MCL 41 DH
FZR	600	R	4JH	94-95	41	MCL 45 EC	MCL 45 RAC-S MCL 41 DH
FZR	600	R	4MH	94-95	41	MCL 45 EC	MCL 45 RAC-S MCL 41 DH
YZF	600	Thunder Cat	4TV,4WD	96-03	41	MCL 45 EC	MCL 45 RAC-S MCL 41 DH
YZF	600	R6	RJ03	99-02	43	MCL 45 EC	MCL 45 RAC-S MCL 43 DH
YZF	600	R6	RJ05	03	43	MCL 45 EC	MCL 45 RAC-S MCL 43 DH
YZF	600	R6	RJ09	04-05	50	MCL 50 EC	MCL 50 RAC-S
YZF	600	R6	RJ11	06	50	MCL 50 EC	MCL 50 RAC-S
YZF	600	R6	RJ15	08-16	50	MCL 50 EC	MCL 50 RAC-S
YZF	750	R	4HN	93-96	50	MCL 50 EC	MCL 50 RAC-S
YZF	750	SP	4HT	93-98	50	MCL 50 EC	MCL 50 RAC-S
TRX	850		4UN	96-99	41	MCL 45 EC	MCL

Komplett-Kits in drei Höhen Complete kits in three heights

RELAX 60

- 60 mm Erhöhung
- 4° Kröpfung

RELAX 60

- 60 mm rise
- 4° offset



Ø	Bestell-Nr. Order no.	
45 mm	MCL456CK	MCL456SK
50 mm	MCL506CK	MCL506SK

RELAX 40

- 40 mm Erhöhung
- 4° Kröpfung

RELAX 40

- 40 mm rise
- 4° offset



Ø	Bestell-Nr. Order no.	
45 mm	MCL454CK	MCL454SK
50 mm	MCL504CK	MCL504SK

KOMFORT 20

- 20 mm Erhöhung
- 5,5° Kröpfung

KOMFORT 20

- 20 mm rise
- 5,5° offset



Ø	Bestell-Nr. Order no.	
45 mm	MCL452CK	MCL452SK
50 mm	MCL502CK	MCL502SK
53 mm	MCL532CK	MCL532SK

Bei anderen Gabeldurchmessern Distanzhülsen verwenden (S. 5.38).

Use spacers for other fork diameters (p. 5.38).

Vor Montage Verkleidung, Leitungen, etc. auf Montierbarkeit überprüfen. Ggf. Änderungen notwendig.

Check if installation of fairing, cables, etc. is possible before mounting. Alterations may be necessary.

ERHÖHTE LENKERSTUMMEL KITS – ALL IN ONE

- Komplettpaket inkl. Schellen, Erhöhungen und Lenkerrohr (250 mm), Distanzhülsen und Lenkrrohrstopfen müssen separat bestellt werden
- hochwertige Ausführung aus Alu in attraktivem Design in schwarz oder silber
- entspannte Griffhaltung entlastet die Handgelenke
- Montage über der Gabelbrücke möglich
- bei vielen Modellen ist die Beibehaltung des Verkleidungsoberteils möglich
- Wechsel zum Originalzustand möglich
- passend für viele Motorräder durch Distanzhülsen
- verfügbare Klemmschellen-Durchmesser bei Komfort 20: 45 mm, 50 mm, 53 mm
- verfügbare Klemmschellen-Durchmesser bei Relax 40 und 60: 45 mm und 50 mm

RAISED CLIP-ON KITS – ALL IN ONE

- complete kit including clamps, risers and handlebar tubes (250 mm), spacer sleeves and handlebar plugs have to be ordered separately
- high quality version made of aluminium with attractive black or silver design
- relaxed grip position takes the strain off your wrists
- installation possible above the yoke
- on many models the upper fairing can be retained
- reverting back to the original state possible
- fits a wide range of motorcycles due to spacer sleeves
- available clamp diameters for Comfort 20: 45 mm, 50 mm, 53 mm
- available clamp diameters for Relax 40 and 60: 45 mm and 50 mm



LIEFERUNG ALS KIT!
DELIVERY AS A KIT!

LENKRROHRSTOPFEN AUS TEFLON, 2 STÜCK HANDLEBAR PLUGS FROM TEFLON, 2 PIECES



Bestell-Nr. Order no.	
MCL300 W	
MCL300 S	

LENKRROHRSTOPFEN AUS ALUMINIUM, 2 STÜCK HANDLEBAR PLUGS FROM ALUMINIUM, 2 PIECES



Bestell-Nr. Order no.	
MCL310 C	
MCL310 S	

BESTELLMINWEIS

Bitte gewünschte Farbe ergänzen!
(Beispiel: MCL 532 **SK** = Schwarz
MCL 532 **CK** = Silber).

ORDER INFORMATION

Please indicate colour:
(example: MCL 532 **SK** = Black
MCL 532 **CK** = Silver).

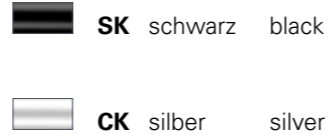

						I 20 mm	I 40 mm	I 60 mm	
Aprilia									
RSV	1000	Mille	ME	98-00	53	MCL 532			
RSV	1000	Mille	RP	01-03	53	MCL 532			
RSV	1000	R	RP / ME	01-03	51	MCL 532			MCL 51 DH
SL	1000	Falco	PA	00-05	51	MCL 532			MCL 51 DH
RSV	1000	R Factory	RR	03-10	51	MCL 532			MCL 51 DH
RSV4	1000	Factory	RK	10-12	51	MCL 532			MCL 51 DH
RSV4	1000	Factory APRC	RK	11-14	51	MCL 532			MCL 51 DH
RSV4	1000	R	RK	10	51	MCL 532			MCL 51 DH
RSV4	1000	R APRC	RK	11-15	51	MCL 532			MCL 51 DH
RSV4	1000	RF APRC	KE	17-	51	MCL 532			MCL 51 DH
RSV4	1000	RR	RK	15-16	51	MCL 532			MCL 51 DH
Ducati									
	748	S, SP, SPS	748	95-00	53	MCL 532			
	748		H3	99-03	53	MCL 532			
	749	R, S	H5	03-07	53	MCL 532			
	750	SS	750SC	91-98	50	MCL 502	MCL 504	MCL 506	
	750	SS i.E.	V2	99-02	50	MCL 502	MCL 504	MCL 506	
	848	, EVO	H6	08-11	53	MCL 532			
	888	Strada	888 S	93-96	50	MCL 502	MCL 504	MCL 506	
	900	SS	906SC	91-98	50	MCL 502	MCL 504	MCL 506	
	900	SS i.E.	V1	98-02	50	MCL 502	MCL 504	MCL 506	
	916	Strada, SPO, SP	916S	94-98	53	MCL 532			
	916	SPS	916S	97-98	53	MCL 532			
	996	SPS	H1	97-01	53	MCL 532			
	998	, S	H2	01-04	53	MCL 532			
	999	, S, R, Biposta	H4	02-06	53	MCL 532			
	1098	, R, S	H7	07-09	53	MCL 532			
	1198	, S, SP, R	H7	09-11	53	MCL 532			
	1199	Panigale S	H8	12-15	53	MCL 532			
	1199	Panigale R	H8	13-16	53	MCL 532			
Honda									
CBR	600	F	PC25	91-94	41	MCL 452	MCL 454	MCL 456	MCL 41 DH
CBR	600	F	PC31	95-98	41	MCL 452	MCL 454	MCL 456	MCL 41 DH
CBR	600	F	PC35	99-07	43	MCL 452	MCL 454	MCL 456	MCL 43 DH
CBR	600	RR	PC37	03-04	45	MCL 452	MCL 454	MCL 456	
CBR	600	RR	PC37	05-06	48	MCL 502	MCL 504	MCL 506	MCL 48 DH
CBR	600	RR	PC40	07-16	41	MCL 452	MCL 454	MCL 456	MCL 41 DH
VFR	800		RC46	98-01	41	MCL 452	MCL 454	MCL 456	MCL 41 DH
VFR	800		RC46	02-05	43	MCL 452	MCL 454	MCL 456	MCL 43 DH
CBR	900	RR Fireblade	SC28	92-95	45	MCL 452	MCL 454	MCL 456	
CBR	900	RR Fireblade	SC33	96-99	45	MCL 452	MCL 454	MCL 456	
CBR	900	RR Fireblade	SC44	00-01	50	MCL 502	MCL 504	MCL 506	
CBR	900	RR Fireblade	SC50	02-03	50	MCL 502	MCL 504	MCL 506	
CBR	1000	RR Fireblade	SC57	04-07	50	MCL 502	MCL 504	MCL 506	
CBR	1000	RR Fireblade	SC59	08-16	50	MCL 502	MCL 504	MCL 506	
CBR	1000	RR Fireblade SP	SC59	14-	53	MCL 532			
CBR	1000	F Dual	SC24	93-01	41	MCL 452	MCL 454	MCL 456	MCL 41 DH
VTR	1000	Firestorm	SC36	97-08	41	MCL 452	MCL 454	MCL 456	MCL 41 DH
VTR	1000	SP1	SC45	00-01	50	MCL 502	MCL 504	MCL 506	
VTR	1000	SP2	SC45	02-07	50	MCL 502	MCL 504	MCL 506	
CBR	1100	XX Blackbird	SC35	97-08	43	MCL 452	MCL 454	MCL 456	MCL 43 DH
Kawasaki									
ZXR	400		ZX400L	91-03	50	MCL 502	MCL 504	MCL 506	
ZX-6R	600	Ninja	ZX600F	94-97	41	MCL 452	MCL 454	MCL 456	MCL 41 DH
ZX-6R	600	Ninja	ZX600G	98-99	46	MCL 502	MCL 504	MCL 506	MCL 46 DH
ZX-6R	600	Ninja	ZX600J	00-02	46	MCL 502	MCL 504	MCL 506	MCL 46 DH
ZX-6RR	600	Ninja	ZX600K	03-04	50	MCL 502	MCL 504	MCL 506	
ZX-6RR	600	Ninja	ZX600N	05-06	50	MCL 502	MCL 504	MCL 506	
ZX-6R	600	Ninja	ZX600P	07-08	50	MCL 502	MCL 504	MCL 506	
ZX-6R	600	Ninja	ZX600R	09-16	51	MCL 532			MCL 51DH
ZX-6R	636	Ninja	ZX636A	02	46	MCL 502	MCL 504	MCL 506	MCL 46 DH
ZX-6R	636	Ninja	ZX636B	03-04	50	MCL 502	MCL 504	MCL 506	
ZX-6R	636	Ninja	ZX636C	05-06	50	MCL 502	MCL 504	MCL 506	
ZX-7R	750		ZX750P	96-02	52	MCL 532			MCL 52 DH
ZXR	750	Ninja	ZX750K/L/M	92-95	52	MCL 532			MCL 52 DH
ZX-9R	900	Ninja	ZX900B	94-97	52	MCL 532			MCL 52 DH

						I 20 mm	I 40 mm	I 60 mm	
ZX-9R	900	Ninja	ZX900C	98-00	46	MCL 502			MCL 46 DH
ZX-9R	900	Ninja	ZX900E	01-04	46	MCL 502	MCL 504	MCL 506	MCL 46 DH
Z	1000		ZRT 00 A	03-06	50	MCL 502	MCL 504	MCL 506	
ZX-10R	1000	Ninja	ZXT00C	04-05	50	MCL 502	MCL 504	MCL 506	
ZX-10R	1000	Ninja	ZXT00D	06-07	50	MCL 502			
ZX-10R	1000	Ninja	ZXT00E	08-09	50	MCL 502	MCL 504	MCL 506	
ZX-10R	1000	Ninja	ZXT00F	10-11	50	MCL 502	MCL 504		
ZX-10R	1000	Ninja	ZXT00J, K	10-15	50	MCL 502	MCL 504		
ZZR	1100		ZXT10D	94-01	43	MCL 452	MCL 454	MCL 456	MCL 43 DH
ZZR	1200		ZXT20C	02-05	43	MCL 452	MCL 454	MCL 456	MCL 43 DH
ZZR	1400		ZXT40A	06-07	43	MCL 452	MCL 454	MCL 456	MCL 43 DH
ZZR	1400		ZXT40C	08-11	43	MCL 452	MCL 454	MCL 456	MCL 43 DH
ZZR	1400		ZXT40E	12-15	43	MCL 452	MCL 454	MCL 456	MCL 43 DH
KTM									
RC	390			14-	43	MCL 452	MCL 454	MCL 456	MCL 43 DH
RC8	1190	R		09-15	43	MCL 452	MCL 454	MCL 456	MCL 43 DH
MV Agusta									
F3	675			15	50	MCL 502			
F3	800			14-	50	MCL 502			
Suzuki									
RGV	250		VJ22A	91-92	50	MCL 502	MCL 504	MCL 506	
GSXR	600		VVVB	01-03	45	MCL 452	MCL 454	MCL 456	
GSXR	600		VVVB2	04-05	50	MCL 502	MCL 504	MCL 506	
GSXR	600		VVCE	06-07	50	MCL 502	MCL 504	MCL 506	
GSXR	600		VVVCV	08-10	50	MCL 502	MCL 504	MCL 506	
GSXR	600		C3	11-16	50	MCL 502	MCL 504	MCL 506	
SV	650	S	AV111	99-02	41	MCL 452	MCL 454	MCL 456	MCL 41 DH
SV	650	S	VVVB	03-09	41	MCL 452	MCL 454	MCL 456	MCL 41 DH
GSXR	750		GR7AB	90-91	50	MCL 502	MCL 504	MCL 506	
GSXR	750		GR7BB	92-95	50	MCL 502	MCL 504	MCL 506	
GSXR	750		GR7DB	96-99	50	MCL 502	MCL 504	MCL 506	
GSXR	750		VVBD	00-03	50	MCL 502	MCL 504	MCL 506	
GSXR	750		VVVB3	04-05	50	MCL 502	MCL 504	MCL 506	
GSXR	750		VVVC	06-07	50	MCL 502	MCL 504	MCL 506	
GSXR	750		VVVCW	08-10	50	MCL 502	MCL 504	MCL 506	
GSXR	750		C4	11-16	50	MCL 502	MCL 504	MCL 506	
GSXR	750		GR7DB	97-99	50	MCL 502	MCL 504	MCL 506	
RF	900	R	GT73B	94-97	43	MCL 452	MCL 454	MCL 456	MCL 43 DH
GSXR	1000		VVBL	01-02	50	MCL 502	MCL 504	MCL 506	
GSXR	1000		VVVB2	03-04	50	MCL 502	MCL 504	MCL 506	
GSXR	1000		VVVB6	05-06	50	MCL 502	MCL 504	MCL 506	
GSXR	1000		VVCL	07-08	50	MCL 502	MCL 504	MCL 506	
GSXR	1000		VVVCV	09-16	50	MCL 502	MCL 504	MCL 506	
GSXR	1100		GV73C	90-92	52	MCL 532			MCL 52 DH
GSXR	1100	W	GU75C	93-97	52	MCL 532			MCL 52 DH
GSXR	1100	W	GU75C	93-97	50	MCL 502	MCL 504	MCL 506	
SV	1000	S	VVVBX	03-05	46	MCL 502	MCL 504	MCL 506	MCL 46 DH
TL	1000	S	AG111	97-01	50	MCL 502	MCL 504	MCL 506	
TL	1000	R	AM321	98-02	50	MCL 502	MCL 504	MCL 506	
GSXR	1100	W	GU75C	93-97	50	MCL 502	MCL 504	MCL 506	
GSXR	1300	R Hayabusa	VVA1	99-07	50	MCL 502	MCL 504	MCL 506	
GSXR	1300	R Hayabusa	VVCK	08-12	50	MCL 502	MCL 504	MCL 506	
Triumph									
	600	Daytona	806 LW	03-04	43	MCL 452	MCL 454	MCL 456	MCL 43 DH
	600	Speed Four	806LB	02-05	43	MCL 452	MCL 454	MCL 456	MCL 43 DH
	650	Daytona	865 LX	05	43	MCL 452	MCL 454	MCL 456	MCL 43 DH
	675	Daytona	D67LC	06-12	50	MCL 502	MCL 504	MCL 506	
	675	Daytona	H67	12-16	50	MCL 502	MCL 504	MCL 506	
	900	Speed Triple	T300B	94-96	43	MCL 452	MCL 454	MCL 456	MCL 43 DH
	900	Speed Triple	T509	97-98	43	MCL 452	MCL 454	MCL 456	MCL 43 DH
	900	Thrupton	986ME	04-	41	MCL 452	MCL 454	MCL 456	MCL 41 DH
	955	Daytona	T595	96-01	45				

						I 20 mm	I 40 mm	I 60 mm	
YZF	600	R6	RJ15	08-	50	MCL 502	MCL 504	MCL 506	
YZF	600	R6	RJ155	11-	43	MCL 452	MCL 454	MCL 456	MCL 41 DH
YZF	750	R	4HN	93-96	50	MCL 502	MCL 504	MCL 506	
YZF	750	SP	4HT	93-98	50	MCL 502	MCL 504	MCL 506	
TRX	850		4UN	96-99	41	MCL 452	MCL 454	MCL 456	MCL 41 DH
FZR	1000	ex up	3LE	89-90	43	MCL 452	MCL 454	MCL 456	MCL 43 DH
FZR	1000	upside down	3LE	91-95	50	MCL 502	MCL 504	MCL 506	
YZF	1000	Thunder Ace	4VD	96-02	48	MCL 502	MCL 504	MCL 506	MCL 48 DH
YZF	1000	R1	RN01	98-00	50	MCL 502	MCL 504	MCL 506	
YZF	1000	R1	RN04	01	50	MCL 502	MCL 504	MCL 506	
YZF	1000	R1	RN09	02-03	50	MCL 502	MCL 504	MCL 506	
YZF	1000	R1, SP	RN12	04-06	50	MCL 502	MCL 504	MCL 506	
YZF	1000	R1	RN19	07-08	50	MCL 502	MCL 504	MCL 506	
YZF	1000	R1	RN22	09-14	50	MCL 502	MCL 504	MCL 506	
YZF	1000	R1	RN32	15-16	43	MCL 452	MCL 454	MCL 456	MCL 43 DH
FJ	1200	A	3YA	91-95	41	MCL 452	MCL 454	MCL 456	MCL 41 DH

Für Individualisten

For individualists

- drei verschiedene Erhöhungen in schwarz oder silber
- Lenkerrohre in vier Farben und jeweils zwei Längen
- Lenkerstopfen in zwei verschiedenen Materialien und jeweils zwei verschiedenen Farben

- three different risers in black or silver
- handlebar tubes in four colours and two lengths each
- handlebar plugs in two different materials and two different colours each



KLEMMSCHELLEN-SET (2 STÜCK)

- mit 20 mm Erhöhung, in schwarz und silber erhältlich

CLAMP KIT (2 PIECES)

- with 20 mm rise, available in black and silver



Ø	Bestell-Nr. Order no.	
45 mm	MCL452C	MCL452S
50 mm	MCL502C	MCL502S
53 mm	MCL532C	MCL532S

BASIS-SET MIT KLEMMSCHELLEN (2 STÜCK)

- Ø 45 oder 50 mm, in schwarz und silber erhältlich
- Aufnahme in gewünschter Höhe separat bestellen (siehe rechts)

LENKROHRAUFNAHME-SET (2 STÜCK)

- in 40 oder 60 mm Höhe, in schwarz und silber erhältlich
- für Basis-Set Klemmschellen

THE BASIC SET WITH CLAMPS (2 PIECES)

- Ø 45 or 50 mm, available in black and silver
- order the fitting for the required height separately (see right)

HANDLEBAR FITTING (2 PIECES)

- in 40 or 60 mm height, available in black and silver
- for Basic set clamps



Ø	Bestell-Nr. Order no.	
45 mm	MCL45C	MCL45S
50 mm	MCL50C	MCL50S

I	Bestell-Nr. Order no.	
40 mm	MCL40LAC	MCL40LAS
60 mm	MCL60LAC	MCL60LAS

LENKERROHRE FÜR EC UND RELAX MODELLE

- eloxierte Lenkrohre mit 3 mm Wandstärke zur Verwendung mit TRW Stummellenkern (1 Stück)

HANDLEBARTUBES FOR EC AND RELAX MODELS

- anodised handlebar tubes with 3 mm material thickness for use with TRW clip-ons (1 piece)



┌─┐	Bestell-Nr. Order no.					
250 mm	MCL250 C	MCL250 R	MCL250 S	MCL250 B		
285 mm	MCL285 C	MCL285 R	MCL285 S	MCL285 B		

LENKERROHRE FÜR SP MODELLE

- eloxierte Lenkrohre mit 3 mm Wandstärke zur Verwendung mit TRW Stummellenkern (1 Stück)
- Verwendung auch für Harley Lenker zur Umrüstung auf 22 mm



┌─┐	Bestell-Nr. Order no.
250 mm	MCL250 S-SP
285 mm	MCL285 S-SP

HANDLEBARTUBES FOR SP MODELS

- anodised handlebar tubes with 3 mm material thickness for use with TRW clip-ons (1 piece)
- can also be used to convert Harley handlebars to 22 mm

LENKROHRSTOPFEN

- aus Teflon
- 2 Stück



HANDLEBAR PLUGS

- made of teflon
- 2 pieces

Bestell-Nr. Order no.	
MCL300 W	
MCL300 S	

LENKROHRSTOPFEN

- aus Aluminium
- 2 Stück



HANDLEBAR PLUGS

- made of aluminium
- 2 pieces

Bestell-Nr. Order no.	
MCL310 C	
MCL310 S	

DISTANZHÜLSEN

- zur Anpassung an verschiedene Gabeldurchmesser
- 2 Stück



SPACERS

- for adapting to different fork diameters
- 2 pieces

∅	Bestell-Nr. Order no.
38 mm	MCL38DH
41 mm	MCL41DH
43 mm	MCL43DH
46 mm	MCL46DH
48 mm	MCL48DH
51 mm	MCL51DH
52 mm	MCL52DH

Racing-Stummel für Harley-Davidson

Der beste und einfachste Weg, einem Bike den Look eines Café Racers zu verleihen. Dabei überraschend komfortabel durch die moderate Geometrie mit einem Lenkrohrwinkel von 5,5 Grad

- feinste, dennoch sehr robuste CNC-Frästeile aus hochfestem Aluminium
- aufgeräumtes Design, perfekt an cleanen Bikes
- Lenkrohre in 25,4 mm (1 Zoll)
- 4 verschiedene Klemmschellendurchmesser
- attraktives Finish, schwarz und silbern eloxiert

Racing clip-ons for Harley-Davidson

The best and easiest way to convert custom bikes to the café racer look. Surprisingly comfortable thanks to the moderate geometry with a handlebar angle of 5.5 degrees

- finest yet very robust CNC milled parts made of high strength aluminium
- clean design, perfect on cleaned bikes
- handlebar tubes in 25.4 mm (1 inch)
- 4 different clamp diameter
- attractive finish, black and silver anodised



SET!
ROHR MIT KABELKERBE

SET!
TUBE WITH CABEL NOTCH

∅	Bestell-Nr. Order no.	
35 mm	MCL35RAC-C	MCL35RAC-S
39 mm	MCL39RAC-C	MCL39RAC-S
41 mm	MCL41RAC-C	MCL41RAC-S
49 mm*	MCL49RAC-C	MCL49RAC-S

* Ausführung mit Distanzhülse | * Version with spacer

LENKERROHR OHNE SCHELLE

- Rohr mit Kabelkerbe (☺) oder ohne Kabelkerbe (X)

HANDLEBARTUBE WITHOUT CLAMP

- tube with cable notch (☺) or without cable notch (X)

┌─┐	Bestell-Nr. Order no.	
☺ 285 mm	MCL254CK	MCL254SK
X 285 mm	MCL254C	MCL254S



Mit Sicherheit immer auf Ideallinie!

Jede Situation perfekt im Griff. Mit optimal zu deinem Bike passenden Stahl- und Alulenkern.
Als Superbike-, Speedfighter-, Sport- oder Customlenker. In allen gängigen Rohrdurchmessern verfügbar.



Always holding the ideal line with confidence and safety!

A perfect handle on every situation. With steel or aluminum handlebars that perfectly fit your bike.
As a superbike, speedfighter, sport or custom handlebar. Available in all common tube diameters.



Hebel Levers



Brems- und Kupplungshebel »Street« Brake and clutch levers »Street«

MIT ABE

- fein einstellbares Drehrad
- CNC gefräste Hebel aus hochwertigem Aluminium
- ergonomisch geformt, mit 80 mm Grifflänge
- formschöne Leichtbauweise mit cleanem Design
- gute Dosierung und exzellentes Griffgefühl
- Sollbruchstelle am Hebel erhöht die Sicherheit
- Farben Hebel: Schwarz, Silber, Titan (Gold als Sonderfarbe auf Wunsch)
- standardmäßig mit schwarzem Versteller, weitere Farben siehe Seite 5.48

WITH TÜV APPROVAL

- fine-adjustment wheel
- CNC milled levers made of high quality aluminium
- ergonomic design, with 80 mm grip length
- appealing, clean and lightweight design
- good modulation and excellent feel
- defined breaking point on the lever for increased safety
- lever colours: black, silver, titanium (gold on special request)
- with black adjuster as a standard, additional colours see page 5.48

**LANG
 LONG**



Brems- und Kupplungshebel »Racing« Brake and clutch levers »Racing«

MIT ABE

- fein einstellbares Drehrad
- CNC gefräste Hebel aus hochwertigem Aluminium
- ergonomisch geformt, mit 50 mm Grifflänge
- formschöne Leichtbauweise mit cleanem Design
- gute Dosierung und exzellentes Griffgefühl
- Sollbruchstelle am Hebel erhöht die Sicherheit
- Farben Hebel: Schwarz, Silber, Titan (Gold als Sonderfarbe auf Wunsch)
- standardmäßig mit schwarzem Versteller, weitere Farben siehe Seite 5.48





WITH TÜV APPROVAL

- fine-adjustment wheel
- CNC milled levers made of high quality aluminium
- ergonomic design, with 50 mm grip length
- appealing, clean and lightweight design
- good modulation and excellent feel
- defined breaking point on the lever for increased safety
- lever colours: black, silver, titanium (gold on special request)
- with black adjuster as a standard, additional colours see page 5.48

**KURZ
 SHORT**



<p>BESTELNHINWEIS</p> <p>Ihre gewünschte Farbe bestellen Sie, indem Sie der Bestellnummer das entsprechende Kürzel hinzufügen (Beispiel: MK5030S = Ausführung in Schwarz). Die Sonderfarbe Gold bestellen Sie bitte per E-Mail.</p>	<p>ORDER INFORMATION</p> <p>You can order your desired colour by adding the corresponding abbreviation to the order number (example: MK5030S = version in black). Please order the custom colour gold by e-mail.</p>
--	---

	S	schwarz	black
	T	titan	titanium
	C	silber	silver
	-	gold	gold

ACHTUNG!
 Andere Farbkombinationen als Sonderanfertigung bestellbar (S. 5.48)

ATTENTION!
 Order other colour combinations as a special design (p. 5.48)



Sonderanfertigungen und Ersatzteile Custom designs and spare parts

**2 LÄNGEN
2 LENGTHS**



HEBEL ALS ERSATZTEIL

- verfügbar in zwei Längen und vier Farben (Schwarz, Titan, Silber, Gold)
- Versteller bitte separat bestellen
- detaillierte Beschreibung siehe S. 5.46 - 5.47

LEVERS AS SPARE PARTS

- available in two lengths and four colours (black, titanium, silver, gold)
- please order adjuster separately
- detailed description see p. 5.46 - 5.47

Bestell-Nr. Hebel, lang Order no. levers, long		Bestell-Nr. Hebel, kurz Order no. levers, short	
MKH500S	MBH500S	MKH100S	MBH100S
MKH500T	MBH500T	MKH100T	MBH100T
MKH500C	MBH500C	MKH100C	MBH100C
MKH500G	MBH500G	MKH100G	MBH100G

VERSTELLER-KIT

- Verstellrad in sechs Farben zur Auswahl: Rot, Schwarz, Blau, Titan, Silber und Gold
- Lieferung umfasst je Kit ein Verstellrad, eine Schraube, eine Kugel und eine Feder für einen Hebel

ADJUSTER KIT

- adjuster wheel in six colours: red, black, blue, titanium, silver and gold
- each kit includes one adjuster wheel, one screw, one ball and one spring for one lever



Bestell-Nr. Order no.	
MHV100R	MHV100T
MHV100S	MHV100C
MHV100B	MHV100G







HINWEIS







Auf Wunsch auch Sonderanfertigung möglich: Für jedes Motorradmodell können Hebel und Versteller in allen erhältlichen Farben kombiniert werden.







REMARK





Also available as a customised version on request: levers and adjusters in all available colours can be combined for all motorcycle models.







Aprilia							
RX	125	RV	08-09	-	MB5100	-	MB1010
SX	125	RV	08-09	-	MB5100	-	MB1010
SL	750 Shiver	RA	07-09	MK5030	MB5210	MK1030	MB1210
SL	750 Shiver	RA	13-14	MK5030	MB5100	MK1030	MB1100
SMV	750 Dorsoduro	SM	08-09	-	MB5210	-	MB1210
SMV	750 Dorsoduro ABS	SM	10-11	-	MB5020	-	MB1020
NA	850 Mana	RC	07-08	-	MB5100	-	MB1100
NA	850 Mana GT ABS	RC	09-10	-	MB5100	-	MB1100
SRV	850 i.e., ABS	M55	12-13	MK5030	MB5100	MK1030	MB1100
SMV	900 Dorsoduro ABS	KB	17-	MK5030	MB5210	MK1030	MB1210
SMV	900 Dorsoduro ABS	YA	17-	MK5030	MB5210	MK1030	MB1210
SL	900 Shiver ABS	YA	17-	MK5030	MB5210	MK1030	MB1210
ETV	1000 Caponord	PS	02-07	MK5030	MB5100	MK1030	MB1100
RST	1000 Mille Futura	PW	01-04	MK5030	MB5020	MK1030	MB1020
RSV	1000 Mille, R	ME	98-00	MK5030	MB5020	MK1030	MB1020
RSV	1000 Mille	RP	01-03	MK5030	MB5020	MK1030	MB1020
RSV	1000 R	RR	04-	MK5030	MB5020	MK1030	MB1020
RSV	1000 R Factory	RR	05-09	MK5140	MB5110	MK1140	MB1110
RSV	1000 Tuono R	RP	03-05	MK5030	MB5020	MK1030	MB1020
RSV	1000 Tuono R	RR	06-08	MK5140	MB5110	MK1140	MB1110
RSV4	1000 Factory	RK	10-12	MK5091	MB5110	MK1091	MB1110
RSV4	1000 Factory APRC	RK	13-	MK5091	MB5110	MK1091	MB1110
RSV4	1000 R APRC	RK	15-	MK5091	MB5110	MK1091	MB1110
RSV4	1000 R APRC	KE	17-	MK5091	MB5110	MK1091	MB1110
SL	1000 Falco	PA	00-04	MK5030	MB5020	MK1030	MB1020
V4	1000 R Tuono	TY	11-12	MK5030	MB5020	MK1030	MB1020
V4	1000 R Tuono	TY	13-14	MK5091	MB5020	MK1091	MB1020
V4	1100 RR Tuono	TY	15-16	MK5091	MB5020	MK1091	MB1020
V4	1000 RR Tuono	KG	17-	MK5091	MB5110	MK1091	MB1110
V4	1100 Tuono Factory ABS	TY	15-16	MK5091	MB5020	MK1091	MB1020
V4	1000 Tuono Factory ABS	KG	17-	MK5091	MB5110	MK1091	MB1110
ETV	1200 CapoNord	VK	13-	MK5030	MB5020	MK1030	MB1020
ETV	1200 CapoNord ABS	VK	13-17	MK5030	MB5020	MK1030	MB1020
SMV	1200 Dorsoduro	TV	11-13	MK5030	MB5020	MK1030	MB1020
Benelli							
TNT	899 Tornado Naked Tre	TN	07-09	-	MB5020	-	MB1020
Tre-K	899	TK	10-11	-	MB5020	-	MB1020
	900 Tornado TRE	TB	02-05	-	MB5020	-	MB1020
Tre-K	1130 Amazonas	TK	07-	MK5140	MB5100	MK1140	MB1100
Tre-K	1130	TK	06-07	MK5140	MB5100	MK1140	MB1100
Tre-K	1130 Tornado TRE	TK	06-14	MK5140	MB5100	MK1140	MB1100
TNT	1130	TN	04-06	-	MB5020	-	MB1020
	1130	TB	07-08	-	MB5100	-	MB1100
Bimota							
DB5	1100 R	DB05	08-	MK5030	MB5020	MK1030	MB1020
DB5	1100 S	DB05	06-08	MK5030	MB5020	MK1030	MB1020
DB6	1100 Delirio	DB06	07	MK5030	MB5020	MK1030	MB1020
DB6	1100 R Delirio	DB06	08-	MK5030	MB5020	MK1030	MB1020
DBX	1100	DB0X	14-	MK5030	MB5100	MK1030	MB1100
	1100 Tesi 3D, Evo, Naked	BT3D	08-	MK5140	MB5110	MK1140	MB1110
DB7	1100	DB07	08-10	MK5030	MB5020	MK1030	MB1020
BMW							
G	650 GS	E650G	11-	MK5280	MB5170	MK1280	MB1170
G	650 Xcountry	E65X	07-10	-	MB5010	-	MB1010
G	650 Xmoto	E65X	07-10	-	MB5010	-	MB1010
F650	800 GS	E8GS	08-12	MK5280	MB5170	MK1280	MB1170
F700	800 GS	E8GS	13-15	MK5280	MB5170	MK1280	MB1170
F700	800 GS ABS	4G80r	16-	MK5210	MB5170	MK1210	MB1170
F700	800 GS ABS	4G80	16-17	MK5210	MB5170	MK1210	MB1170
F800	800 GS	E8GS	08-12	MK5280	MB5170	MK1280	MB1170
F800	800 GS Adventure	E8GS	13-15	MK5280	MB5170	MK1280	MB1170
F800	800 GS	4G80	16-17	MK5210	MB5170	MK1210	MB1170







								
F800	800	GS Adventure	4G80	16-17	MK5210	MB5170	MK1210	MB1170
F800	800	GT	E8ST	13-	MK5280	MB5170	MK1280	MB1170
F800	800	GT	4R80	17-	MK5280	MB5170	MK1280	MB1170
F800	800	R	E8ST	09-15	MK5280	MB5170	MK1280	MB1170
F800	800	R, R ABS	4R80	17-	MK5280	MB5170	MK1280	MB1170
F800	800	S	E8ST	06-10	MK5280	MB5170	MK1280	MB1170
F800	800	ST	E8ST	06-12	MK5280	MB5170	MK1280	MB1170
HP4	1000	RR	K10	12-	MK5231	MB5071	MK1231	MB1071
S	1000	R	K10	09-10	MK5231	MB5071	MK1231	MB1071
S	1000	R	K10	13-14	MK5460	MB5460	MK1460	MB1460
S	1000	R	2R10	16-	MK5231	MB5071	MK1231	MB1071
S	1000	R	2R10r	16-	MK5231	MB5071	MK1231	MB1071
S	1000	RR	K10	09	MK5230	MB5071	MK1230	MB1071
S	1000	RR	K10	09-10	MK5231	MB5071	MK1231	MB1071
S	1000	RR	K10	14-15	MK5231	MB5071	MK1231	MB1071
S	1000	RR	2R10	16-	MK5231	MB5071	MK1231	MB1071
S	1000	RR	2R10r	16-	MK5231	MB5071	MK1231	MB1071
S	1000	XR	K10	15-	MK5460	MB5460	MK1460	MB1460
S	1000	XR	2R10	17-	MK5460	MB5460	MK1460	MB1460
S	1000	XR	2R10r	17-	MK5460	MB5460	MK1460	MB1460
K	1200	R	K12R	05-08	MK5210	MB5170	MK1210	MB1170
K	1200	R Sport	K12R	07-08	MK5210	MB5170	MK1210	MB1170
K	1200	S	K12S	05-09	MK5210	MB5170	MK1210	MB1170
R	1200	GS	R12	04-	MK5210	MB5170	MK1210	MB1170
R	1200	GS Adventure	R12	06-	MK5210	MB5170	MK1210	MB1170
R	1200	HP2 Enduro	RHP2	04-06	MK5210	MB5170	MK1210	MB1170
R	1200	HP2 Megamoto	RHP2	07-08	MK5210	MB5170	MK1210	MB1170
R	1200	nine T	K21	14-	MK5420	MB5250	MK1420	MB1250
R	1200	nine T	K21	14-	MK5420	MB5250	MK1420	MB1250
R	1200	R	R1ST	06-	MK5210	MB5170	MK1210	MB1170
R	1200	R	R1ST	09-10	MK5420	MB5250	MK1420	MB1250
R	1200	RT	R12T	05-10	MK5420	MB5250	MK1420	MB1250
R	1200	S	R12S	06-	MK5210	MB5170	MK1210	MB1170
R	1200	ST	R1ST	05-	MK5210	MB5170	MK1210	MB1170
K	1300	GT	K12S	09-11	MK5210	MB5170	MK1210	MB1170
K	1300	R	K12S	09-	MK5210	MB5170	MK1210	MB1170
K	1300	S	K12S	09-	MK5210	MB5170	MK1210	MB1170
K	1600	GT	K48	11-	MK5210	MB5170	MK1210	MB1170
Buell								
XB-9S	984	Lightning	XB1	03-08	MK5010	MB5120	MK1010	MB1120
XB-9SX	984	Lightning City X	XB1	05-08	MK5010	MB5120	MK1010	MB1120
	1125	R, CR	XB3	08-	MK5010	MB5120	MK1010	MB1120
M, M2	1200	Cyclone	EB1	97-02	MK5010	MB5060	MK1010	MB1060
S1, S1-2	1200	Lightning	EB1	98-02	MK5010	MB5060	MK1010	MB1060
X1	1200	Lightning	BL1	98-02	MK5010	MB5060	MK1010	MB1060
XB-12S	1200	Lightning	XB1	04-08	MK5010	MB5120	MK1010	MB1120
XB-12STT	1200	Lightning Super TT	XB2	07-08	MK5010	MB5120	MK1010	MB1120
XB-12S	1200	Lightning Long	XB2	06-08	MK5010	MB5120	MK1010	MB1120
Cagiva								
	650	Raptor	M2	01-08	-	MB5060	-	MB1060
	1000	Raptor	M2	04-	-	MB5060	-	MB1060
Ducati								
	400	Monster	M3	00-01	MK5020	MB5010	MK1020	MB1010
	400	Scrambler Sixty 2	KA	16-	MK5190	MB5010	MK1190	MB1010
	600	Monster	ZDM600M	94-98	MK5020	MB5010	MK1020	MB1010
	600	Monster	ZDM600M3	99-01	MK5020	MB5010	MK1020	MB1010
	600	SS Supersport	600S	94-	MK5020	MB5010	MK1020	MB1010
	620	Monster i.e.	M4	01-05	MK5020	MB5010	MK1020	MB1010
	620	Multistrada	A1	05-	MK5030	MB5020	MK1030	MB1020
	620	Multistrada Dark	A1	05-	MK5030	MB5020	MK1030	MB1020
	620	S i.e. Sport	V5	03-	MK5030	MB5020	MK1030	MB1020
	695	Monster	M4	07-08	MK5030	MB5020	MK1030	MB1020
	696	Monster	M5	07-	MK5030	MB5020	MK1030	MB1020

								
	696	Monster ABS	M5	10-14	MK5030	MB5020	MK1030	MB1020
	748		ZDM748S	99	MK5030	MB5020	MK1030	MB1020
	748	R	H3	99-03	MK5030	MB5020	MK1030	MB1020
	748	SP	ZDM748S	95-96	MK5020	MB5010	MK1020	MB1010
	748	SPS	748	99	MK5030	MB5020	MK1030	MB1020
	749	R	H5	04-07	MK5140	MB5110	MK1140	MB1110
	749	S	H5	03-07	MK5140	MB5110	MK1140	MB1110
	750	Monster	ZDMM1	96-98	MK5020	MB5010	MK1020	MB1010
	750	Monster i.e.	M4	02	MK5020	MB5010	MK1020	MB1010
	750	SS Supersport	S	91-94	MK5020	MB5010	MK1020	MB1010
	750	SS Supersport	S	95-98	MK5020	MB5010	MK1020	MB1010
	750	SS i.e. Supersport	V2	99-02	MK5020	MB5010	MK1020	MB1010
	796	Monster	M5	10-	MK5020	MB5010	MK1020	MB1010
	797	Monster	MD	17-	MK5190	MB5010	MK1190	MB1010
	797	Monster	ME	17-	MK5190	MB5010	MK1190	MB1010
	800	Monster i.e.	M4	03-04	MK5030	MB5020	MK1030	MB1020
	800	Monster S2R	M4	05-07	MK5030	MB5020	MK1030	MB1020
	800	Scrambler	K1	15-16	MK5190	MB5010	MK1190	MB1010
	800	Scrambler	KC	17-	MK5190	MB5010	MK1190	MB1010
	800	Scrambler Desert Sled ABS	KE	17-	MK5190	MB5010	MK1190	MB1010
	800	Scrambler Desert Sled ABS	KB	17-	MK5190	MB5010	MK1190	MB1010
	800	Scrambler Café Racer ABS	KD	17-	MK5190	MB5010	MK1190	MB1010
	800	SS i.e. Supersport	V5	03-	MK5030	MB5020	MK1030	MB1020
	821	Hyperstrada	B2,B3	13	MK5190	MB5010	MK1190	MB1010
	821	Hypermotard, SP	B2,B3	13	MK5190	MB5010	MK1190	MB1010
	821	Monster	M6	14-	MK5190	MB5010	MK1190	MB1010
	821	Monster	MC	16-	MK5190	MB5010	MK1190	MB1010
	821	Monster	MG	17-	MK5190	MB5010	MK1190	MB1010
	821	Monster	MF	16-	MK5190	MB5010	MK1190	MB1010
	848		H6	08-	MK5140	MB5110	MK1140	MB1110
	848	EVO	H6	10-	MK5140	MB5110	MK1140	MB1110
	848	Streetfighter	F1	12-	MK5140	MB5110	MK1140	MB1110
	899	Panigale	H8	14-	MK5140	MB5110	MK1140	MB1110
	900	Monster	ZDM900M	93-99	MK5020	MB5010	MK1020	MB1010
	900	Monster i.e.	M2	00-02	MK5020	MB5010	MK1020	MB1010
	900	Monster i.e.	M4	02	MK5020	MB5010	MK1020	MB1010
SL	900	Superlight	906SC2	92-97	MK5020	MB5010	MK1020	MB1010
	900	SS FE	906SC2	98-	MK5020	MB5010	MK1020	MB1010
	900	SS Supersport	906SC2	91-98	MK5020	MB5010	MK1020	MB1010
	900	SS i.e. Supersport	V1	99-02	MK5030	MB5020	MK1030	MB1020
	916	Monster S4	M4	00-04	MK5030	MB5020	MK1030	MB1020
	916	Monoposto	916S	94-98	MK5020	MB5010	MK1020	MB1010
	916	SP	ZDM916SP	94-96	MK5020	MB5010	MK1020	MB1010
	916	Strada Biposto	1SB8S	95-98	MK5020	MB5010	MK1020	MB1010
ST4	916	Sport Touring	S2	99-	MK5030	MB5020	MK1030	MB1020
	937	Supersport	VA	17-	MK5190	MB5010	MK1190	MB1010
	939	Hypermotard	BA	15-	MK5190	MB5010	MK1190	MB1010
	939	Hypermotard	BA	16-	MK5190	MB5010	MK1190	MB1010
ST2	944	Sport Touring	S1	97-02	MK5030	MB5020	MK1030	MB1020
	950	Multistrada ABS	AA	17-	MK5190	MB5010	MK1190	MB1010
	959	Panigale	HA	16-	MK5140	MB5110	MK1140	MB1110
	996	Biposto	H2	99-01	MK5030	MB5020	MK1030	MB1020
	996	Monster S4R	M4	04-06	MK5030	MB5110	MK1030	MB1110
	996	R	H2	01	MK5030	MB5020	MK1030	MB1020
	996	S	H2	01	MK5030	MB5020	MK1030	MB1020
	996	SPS	H1, H2	00-	MK5030	MB5020	MK1030	MB1020
S2	996	ST4S	S2	01-03	MK5030	MB5020	MK1030	MB1020
S3	996	ST4S	S3	04-05	MK5030	MB5020	MK1030	MB1020
	998	Biposto	H2	02-03	MK5030	MB5020	MK1030	MB1020
	998	S	H2	02-03	MK5030	MB5020	MK1030	MB1020
	999	R	H4	03-06	MK5140	MB5110	MK1140	MB1110
	999	S	H4	03-06	MK5140	MB5110	MK1140	MB1110
GT	1000		C1	06-08	MK5030	MB5020	MK1030	MB1020

								
1000	Monster i.e.	M4	03-06	MK5030	MB5020	MK1030	MB1020	
1000	Monster S2R	M4	08-	MK5030	MB5110	MK1030	MB1110	
1000	Monster S4R	M4	07-08	MK5140	MB5020	MK1140	MB1020	
1000	Monster S4RS	M4	06-08	MK5140	MB5020	MK1140	MB1020	
1000	Sport	C1	06-08	MK5030	MB5020	MK1030	MB1020	
1000	Sport S	C1	07-08	MK5030	MB5020	MK1030	MB1020	
1000	SS Supersport	V5	03-06	MK5030	MB5020	MK1030	MB1020	
1000	ST3	S3	04-07	MK5030	MB5020	MK1030	MB1020	
1000	ST3S	S3	06-07	MK5030	MB5020	MK1030	MB1020	
1098	Panigale S, R, ABS	H7	07-09	MK5140	MB5110	MK1140	MB1110	
1098	R	H7	07-09	MK5140	MB5110	MK1140	MB1110	
1098	S	H7	07-09	MK5140	MB5110	MK1140	MB1110	
1100	Hypermotard, S	B1	07-	MK5140	MB5110	MK1140	MB1110	
1100	Hypermotard, S	B1	13-	MK5140	MB5110	MK1140	MB1110	
1100	Monster	M5	09-	MK5140	MB5110	MK1140	MB1110	
1000	Multistrada DS	A1	03-04	MK5030	MB5020	MK1030	MB1020	
1000	Multistrada S DS	A1	04-06	MK5030	MB5020	MK1030	MB1020	
1100	Multistrada, S	A1	07-09	MK5030	MB5020	MK1030	MB1020	
1100	S	M5	09-	MK5140	MB5110	MK1140	MB1110	
1100	Streetfighter	F1	09-	MK5140	MB5110	MK1140	MB1110	
1199	Panigale S, R, ABS	H8	12-	MK5140	MB5110	MK1140	MB1110	
1199	Superleggera	H8	14-	MK5140	MB5110	MK1140	MB1110	
1200	Diavel	G1	11-	MK5140	MB5110	MK1140	MB1110	
1200	Diavel	GC	17-	MK5140	MB5110	MK1140	MB1110	
1200	Diavel	G2	11-	MK5140	MB5110	MK1140	MB1110	
1200	Monster, R, S	M6	14-	MK5140	MB5110	MK1140	MB1110	
1200	Monster, R, S	MA	16-	MK5140	MB5110	MK1140	MB1110	
1200	Monster, R, S	MB	16-	MK5140	MB5110	MK1140	MB1110	
1200	Multistrada, S	A2	10-12	MK5140	MB5110	MK1140	MB1110	
1200	Multistrada, S	A3	13-	MK5140	MB5110	MK1140	MB1110	
1200	Multistrada	AA	16-	MK5140	MB5110	MK1140	MB1110	
1200	Multistrada D-air ABS	AA	16-	MK5140	MB5110	MK1140	MB1110	
1200	Multistrada S	AA	16-	MK5140	MB5110	MK1140	MB1110	
1200	Multistrada Enduro ABS, Pro	AA	16-	MK5140	MB5110	MK1140	MB1110	
1200	Multistrada S Pikes Peak	A2	11-	MK5140	MB5110	MK1140	MB1110	
1200	Multistrada S Pikes Peak	AA	16-	MK5140	MB5110	MK1140	MB1110	
1299	Panigale, R, S	H9	15-	MK5140	MB5110	MK1140	MB1110	
Gilera								
GP	800	M55	08-	MK5030	MB5110	MK1030	MB1110	
Honda								
CBR	125	R	JC50	12-	-	MB5210	MB1210	
MSX	125		JC61	15-	MK5350	MB5210	MK1350	
SH	125	i	JF23	09-	MK5340	MB5030	MK1340	
SH	125	A i.	JF41	13-	MK5340	MB5030	MK1340	
SH	125	A i.	JF51	14-	MK5340	MB5030	MK1340	
SH	150	i	KF10	09-	MK5340	MB5030	MK1340	
SH	150	A i.	KF13	13-	MK5340	MB5030	MK1340	
CBR	250	R	MC41	11-13	MK5350	MB5210	MK1350	
CBR	250	RA	MC41	11-13	MK5350	MB5210	MK1350	
NSS	250	Forza	MF08	05-07	MK5340	MB5030	MK1340	
NSS	250	A Forza	MF10	08-	MK5340	MB5030	MK1340	
CBR	300	R, RA	NC51	15-	MK5350	MB5210	MK1350	
SH	300	A i.	NF02	07-	MK5340	MB5030	MK1340	
FJS	400	Silver Wing	NF01	06-08	MK5340	MB5200	MK1340	
FJS	400	D Silverwing	NF03	09-13	MK5340	MB5200	MK1340	
FJS	400	A Silverwing SW-T	NF03	09-13	MK5340	MB5200	MK1340	
CB	500	F	PC45	13-16	MK5350	MB5210	MK1350	
CB	500	FA	PC58	17-	MK5350	MB5210	MK1350	
CB	500	X	PC46	13-16	MK5350	MB5210	MK1350	
CB	500	XA	PC59	17-	MK5350	MB5210	MK1350	
CBR	500	R, RA	PC44	13-16	MK5350	MB5210	MK1350	
CBR	500	R, RA	PC57	17-	MK5350	MB5040	MK1350	
CB	600	F Hornet	PC34	98-99	MK5040	MB5030	MK1040	

								
CB	600	S Hornet	PC34	00-01	MK5040	MB5030	MK1040	MB1030
CB	600	F Hornet	PC36	02-06	MK5040	MB5030	MK1040	MB1030
CB	600	F, S Hornet	PC41	07-11	MK5040	MB5030	MK1040	MB1030
CB	600	F, S Hornet	PC41	12-	-	MB5030	-	MB1030
CBF	600	N, S	PC38	04-07	MK5040	MB5030	MK1040	MB1030
CBF	600	NA, SA	PC43	08-	MK5320	MB5030	MK1320	MB1030
CBR	600	F	PC19	87-88	MK5040	MB5030	MK1040	MB1030
CBR	600	F	PC23	89-90	MK5040	MB5030	MK1040	MB1030
CBR	600	F	PC25	91-94	MK5040	MB5030	MK1040	MB1030
CBR	600	F	PC31	95-98	MK5040	MB5030	MK1040	MB1030
CBR	600	F	PC35	99-00	MK5040	MB5030	MK1040	MB1030
CBR	600	F, FA	PC41	11-13	MK5091	MB5030	MK1091	MB1030
CBR	600	FS Sport	PC35	01-07	MK5040	MB5030	MK1040	MB1030
CBR	600	RR	PC37	03-06	MK5091	MB5040	MK1091	MB1040
CBR	600	RR	PC40	07-13	MK5091	MB5050	MK1091	MB1050
FJS	600	A Silverwing	PF01	03-05	MK5340	MB5200	MK1340	MB1200
FJS	600	A Silverwing SW-T	PF01	10-	MK5340	MB5200	MK1340	MB1200
VT	600	C Shadow	PC21	98-	MK5350	MB5200	MK1350	MB1200
CB	650	F, FA	RC75	14-	MK5490	MB5030	MK1490	MB1030
CB	650	F, FA	RC97	18-	MK5490	MB5030	MK1490	MB1030
CBR	650	F, FA	RC74	14-	MK5490	MB5030	MK1490	MB1030
CBR	650	F, FA	RC96	18-	MK5490	MB5030	MK1490	MB1030
NT	650	V Deauville	RC47	02-	MK5040	-	MK1040	-
CTX	700	D	RC69	15-	MK5350	MB5200	MK1350	MB1200
CTX	700	DA, DCT	RC69	15-	MK5350	MB5200	MK1350	MB1200
CTX	700	N	RC68	15-	MK5350	MB5200	MK1350	MB1200
CTX	700	NA, ND-DCT	RC68	15-	MK5350	MB5200	MK1350	MB1200
NT	700	V, VA Deauville	RC52	06-09	MK5040	-	MK1040	-
NC	700	S	RC61	12-14	MK5350	MB5030	MK1350	MB1030
NC	700	SA, SD-DCT	RC61	12-14	MK5350	MB5030	MK1350	MB1030
NC	700	D Integra, SD-DCT	RC62	12-13	MK5340	MB5200	MK1340	MB1200
NC	700	X	RC63	12-	MK5350	MB5030	MK1350	MB1030
	750	X-ADV ABS	RC95	17-	MK5340	MB5200	MK1340	MB1200
CBX	750	F	RC17	84-	MK5120	MB5200	MK1120	MB1200
NC	750	S, SA, SD-DCT	RC70	14-15	MK5350	MB5030	MK1350	MB1030
NC	750	X, XA, XD-DCT	RC72	14-15	MK5350	MB5030	MK1350	MB1030
NC	750	XA, XD-DCT	RC90	16-	MK5490	MB5030	MK1490	MB1030
NC	750	SA, SD-DCT	RC88	16-	MK5490	MB5030	MK1490	MB1030
VFR	800	FI	RC46	98-01	MK5060	MB5030	MK1060	MB1030
VFR	800	A	RC46	02-09	MK5060	MB5030	MK1060	MB1030
VFR	800	F	RC79	14-16	MK5060	MB5030	MK1060	MB1030
VFR	800	F	RC93	17-18	MK5060	MB5030	MK1060	MB1030
VFR	800	XA Crossrunner	RC60	11-	MK5060	MB5030	MK1060	MB1030
VFR	800	X Crossrunner	RC80	15-	MK5060	MB5030	MK1060	MB1030
CB	900	F Hornet	SC48	02-	MK5040	MB5030	MK1040	MB1030
CBR	900	RR Fireblade	SC28	92-95	MK5040	MB5030	MK1040	MB1030
CBR	900	RR Fireblade	SC33	96-99	MK5040	MB5030	MK1040	MB1030
CBR	900	RR	SC44	00-01	MK5040	MB5040	MK1040	MB1040
CBR	900	RR	SC50	02-03	MK5091	MB5040	MK1091	MB1040
CB	1000	R, RA	SC60	08-9	MK5060	MB5050	MK1060	MB1050
CBF	1000		SC58	06-	MK5060	MB5030	MK1060	MB1030
CBF	1000	F	SC64	10-14	MK5060	MB5030	MK1060	MB1030
CBF	1000	FA	SC64	10-14	MK5060	MB5030	MK1060	MB1030
CBR	1000	RR Fireblade	SC57	04-07	MK5060	MB5050	MK1060	MB1050
CBR	1000	RR Fireblade	SC59	08-	MK5091	MB5050	MK1091	MB1050
CBR	1000	RA Fireblade	SC59	09-	MK5091	MB5050	MK1091	MB1050
CBR	1000	RR Fireblade SP	SC59	14-	MK5091	MB5050	MK1091	MB1050
CBR	1000	RA Fireblade	SC77	17-	MK5091	MB5050	MK1091	MB1050
CBR	1000	RA Fireblade SP	SC77	17-	MK5091	MB5050	MK1091	MB1050
CBR	1000	RA Fireblade SP2	SC77	17-	MK5091	MB5050	MK1091	MB1050
CRF	1000	L Africa Twin	SD04	15-	MK5470	MB5030	MK1470	MB1030
CRF	1000	LA, LD Africa Twin	SD06	17-	MK5470	MB5030	MK1470	MB1030
VTR	1000	Firestorm	SC36	97-00	MK5060	MB5030	MK1060	MB1030

								
VTR	1000	Firestorm	SC36	01-05	MK5060	MB5030	MK1060	MB1030
VTR	1000	SP1	SC45	00-01	MK5060	MB5030	MK1060	MB1030
VTR	1000	SP2	SC45	02-	MK5060	MB5030	MK1060	MB1030
CB	1100	A	SC65	13-16	MK5060	MB5030	MK1060	MB1030
CB	1100	EX ABS	SC78	17-	MK5060	MB5030	MK1060	MB1030
VFR	1200	F, FA	SC63	10-16	MK5060	MB5050	MK1060	MB1050
VFR	1200	X ,XD,XL,XDL	SC70	12-	MK5060	MB5030	MK1060	MB1030
VFR	1200	X ,XD,XL,XDL	SC76	16-	MK5060	MB5050	MK1060	MB1050
CB	1300	A (Superfour)	SC54	05-09	MK5060	MB5050	MK1060	MB1050
CB	1300	F	SC54	03-04	MK5060	MB5030	MK1060	MB1030
CB	1300	S, SA	SC54	05-	MK5060	MB5030	MK1060	MB1030
Horex								
VR6	1200		HX	12-14	MK5030	MB5100	MK1030	MB1100
Kawasaki								
KLX	250	S	LX250S	09-	MK5370	MB5210	MK1370	MB1210
	250	Ninja R	EX250K	07-12	MK5370	MB5210	MK1370	MB1210
	300	Ninja R	EX300A	13-	MK5370	MB5210	MK1370	MB1210
Z	300		EX300A	15-	MK5370	MB5210	MK1370	MB1210
ZXR	400		ZR400E	94-97	MK5220	MB5060	MK1220	MB1060
ER-5	500	Twister	ER500A	97-	MK5220	MB5060	MK1220	MB1060
ER-5	500	Twister	ER500A	01-	MK5220	MB5060	MK1220	MB1060
GPZ	500	S	EX500A	90-	MK5220	MB5060	MK1220	MB1060
GPZ	500	S	EX500D	94-95	MK5220	MB5060	MK1220	MB1060
KLE	500		LE500A	91-97	MK5220	MB5060	MK1220	MB1060
ZZR	600		ZX600E	93-03	MK5220	MB5060	MK1220	MB1060
ZZR	600		ZX600E	0105	MK5070	MB5060	MK1070	MB1060
ZX-6R	600	Ninja	ZX600F	95-97	MK5220	MB5060	MK1220	MB1060
ZX-6R	600	Ninja	ZX600G(G,H)	98-99	MK5070	MB5060	MK1070	MB1060
ZX-6R	600	Ninja	ZX600J	00-02	MK5070	MB5060	MK1070	MB1060
ZX-6R	600	Ninja	ZX600P	07-08	MK5070	MB5090	MK1070	MB1090
ZX-6R	600	Ninja	ZX600R	09-13	MK5070	MB5090	MK1070	MB1090
ZX-6RR	600	Ninja	ZX600K(K,M)	03-04	MK5070	MB5060	MK1070	MB1060
ZX-6RR	600	Ninja	ZX600N	05-06	MK5070	MB5060	MK1070	MB1060
ZX-6R	636	Ninja	ZX636A	02	MK5070	MB5070	MK1070	MB1070
ZX-6R	636	Ninja	ZX636B	03-04	MK5070	MB5070	MK1070	MB1070
ZX-6R	636	Ninja	ZX636C	05-06	MK5070	MB5070	MK1070	MB1070
ZX-6R	636	Ninja	ZX636E	13-	MK5070	MB5090	MK1070	MB1090
	650	Ninja ABS	EX650K	17-	MK5220	MB5120	MK1220	MB1120
	650	Ninja KRT Edition ABS	EX650K	17-	MK5220	MB5120	MK1220	MB1120
ER-6	650	F	EX650A	06-08	MK5220	MB5060	MK1220	MB1060
ER-6	650	F	EX650C	09-11	MK5220	MB5190	MK1220	MB1190
ER-6	650	F	EX650E	12-	MK5220	MB5190	MK1220	MB1190
ER-6	650	N	ER650A	06-08	MK5220	MB5060	MK1220	MB1060
ER-6	650	N	ER650C	09-11	MK5220	MB5190	MK1220	MB1190
ER-6	650	N	ER650E	12-	MK5220	MB5190	MK1220	MB1190
KLE	650	Versys	LE650A	07-09	MK5220	MB5060	MK1220	MB1060
KLE	650	Versys	LE650C	10-14	MK5220	MB5120	MK1220	MB1120
KLE	650	Versys LT	LE650E	15-	MK5220	MB5120	MK1220	MB1120
	650	Vulcan S	EN650A	15-	MK5220	MB5120	MK1220	MB1120
Z	650		ER650H	17-	MK5220	MB5120	MK1220	MB1120
Z	750	S	ZR750J(J,K)	05-06	MK5220	MB5060	MK1220	MB1060
Z	750		ZR750L(L,M)	07-12	MK5070	MB5120	MK1070	MB1120
Z	750	R	ZR750N(N,P)	11-12	MK5070	MB5090	MK1070	MB1090
ZR-7	750		ZR750F	99-04	MK5220	MB5060	MK1220	MB1060
ZR-7	750	S	ZR750F	01-03	MK5220	MB5060	MK1220	MB1060
ZR	750	Zephyr	ZR750C	91-	MK5220	MB5060	MK1220	MB1060
ZR	750	Zephyr	ZR750C(C,D)	96-99	MK5220	MB5060	MK1220	MB1060
ZX-7RR	750	Ninja	ZX750N(N)	96-99	MK5130	MB5060	MK1130	MB1060
ZX-7R	750	Ninja	ZX750N(P)	96-02	MK5130	MB5060	MK1130	MB1060
Z	800		ZR800A(A,B)	13-	MK5070	MB5120	MK1070	MB1120
Z	800	e Version	ZR800C(C,D)	13-	MK5070	MB5120	MK1070	MB1120
Z	800	e Version Special Edition	ZR800F(E)	16-	MK5070	MB5120	MK1070	MB1120
Z	800	e Version Special Edition ABS	ZR800F(F)	16-	MK5070	MB5120	MK1070	MB1120







								
W	800		EJ800A	11-	MK5220	MB5060	MK1220	MB1060
GPZ	900	R Ninja	ZX900A	90-93	MK5130	MB5060	MK1130	MB1060
ZX-9R	900	Ninja	ZX900B	94-97	MK5130	MB5060	MK1130	MB1060
ZX-9R	900	Ninja	ZX900C(C/D)	98-99	MK5220	MB5060	MK1220	MB1060
ZX-9R	900	Ninja	ZX900E(E,F)	00-04	MK5070	MB5060	MK1070	MB1060
Z	900	ABS	ZR900B	17-	MK5220	MB5120	MK1220	MB1120
Z	900	RS, RS Cafe ABS	ZR900C	17-	MK5220	MB5050	MK1220	MB1050
GPZ	1000	RX	ZXT00A	85-	MK5130	MB5060	MK1130	MB1060
GTR	1000		ZGT00A	86-	MK5130	MB5060	MK1130	MB1060
KLZ	1000	Versys	LZT00A	12-14	MK5070	MB5060	MK1070	MB1060
KLZ	1000	Versys	LZT00B	14-	MK5220	MB5120	MK1220	MB1120
KLZ	1000	Versys	LZT00B	16-	MK5220	MB5120	MK1220	MB1120
Z	1000		ZRT00A	03-06	MK5070	MB5060	MK1070	MB1060
Z	1000		ZRT00B(B,C)	07-09	MK5070	MB5090	MK1070	MB1090
Z	1000		ZRT00D(D,E)	10-13	MK5070	MB5090	MK1070	MB1090
Z	1000		ZRT00F(F,G)	14-	MK5070	MB5051	MK1070	MB1051
Z	1000	SX	ZXT00G(H)	11-13	MK5070	MB5090	MK1070	MB1090
Z	1000	SX	ZXT00L(LA)	14-	MK5070	MB5051	MK1070	MB1051
Z	1000		ZRT00H	17-	MK5220	MB5051	MK1220	MB1051
ZX-10R	1000	Ninja	ZXT00C	04-05	MK5070	MB5060	MK1070	MB1060
ZX-10R	1000	Ninja	ZXT00D	06-07	MK5070	MB5090	MK1070	MB1090
ZX-10R	1000	Ninja	ZXT00E	08-09	MK5070	MB5090	MK1070	MB1090
ZX-10R	1000	Ninja	ZXT00F	10	MK5070	MB5090	MK1070	MB1090
ZX-10R	1000	Ninja	ZXT00J(K)	11-15	MK5070	MB5090	MK1070	MB1090
ZX-10R	1000	Ninja	ZXT00J(J)	11-15	MK5070	MB5090	MK1070	MB1090
ZX-10R	1000	Ninja	ZXT00S	16-	MK5070	MB5110	MK1070	MB1110
ZR	1100	Zephyr	ZRT10A	92-	MK5130	MB5060	MK1130	MB1060
ZRX	1100		ZRT10C	96-98	MK5130	MB5060	MK1130	MB1060
ZRX	1100		ZRT10C	98-00	MK5130	MB5060	MK1130	MB1060
ZZR	1100		ZXT10C	90-92	MK5130	MB5060	MK1130	MB1060
ZZR	1100		ZXT10D	93-01	MK5220	MB5060	MK1220	MB1060
ZRX	1200	R	ZRT20A(A)	01-05	MK5130	MB5060	MK1130	MB1060
ZRX	1200	C, S	ZRT20A(B,C)	01-04	MK5130	MB5060	MK1130	MB1060
ZX-12R	1200	Ninja	ZXT20A(A)	00-01	MK5070	MB5060	MK1070	MB1060
ZX-12R	1200	Ninja	ZXT20A(B)	02-06	MK5070	MB5060	MK1070	MB1060
ZZR	1200		ZXT20C	02-05	MK5130	MB5060	MK1130	MB1060
GTR	1400		ZGT40A	07-09	MK5400	MB5090	MK1400	MB1090
GTR	1400		ZGT40C	10-	MK5400	MB5090	MK1400	MB1090
GTR	1400		ZGT40E	15-	MK5400	MB5090	MK1400	MB1090
ZZR	1400		ZXT40A(A,B)	06-07	MK5400	MB5090	MK1400	MB1090
ZZR	1400		ZXT40C(C,D)	08-11	MK5400	MB5090	MK1400	MB1090
ZZR	1400		ZXT40E	12-	MK5400	MB5090	MK1400	MB1090
ZZR	1400		ZXT40H	15-16	MK5400	MB5090	MK1400	MB1090
VN	1500	Classic	VNT50D	96-99	MK5130	MB5060	MK1130	MB1060
VN	1500	Classic Tourer	VNT50G(G,H)	98-99	MK5130	MB5060	MK1130	MB1060
VN	1500	Mean Streak	VNT50P	02-03	MK5130	MB5060	MK1130	MB1060
VN	1600	Mean Streak	VNT60B	04-06	MK5130	MB5060	MK1130	MB1060
VN	1600	Classic	VNT60A	03-08	MK5130	MB5060	MK1130	MB1060
VN	1600	Classic Tourer	VNT60A(D)	05-08	MK5130	MB5060	MK1130	MB1060
KTM								
	125	Duke 4T	KTMISDUKE	11-	MK5190	MB5100	MK1190	MB1100
	125	Duke	KTMISDUKE	17-	MK5190	-	MK1190	-
RC	125		KTMISRC	16	MK5190	-	MK1190	-
	200	Duke	KTMISDUKE	12-	-	MB5100	-	MB1100
RC	390		KTM-IS-RC	16	MK5190	-	MK1190	-
	390	Duke		16	MK5190	-	MK1190	-
	390	Duke	KTMISDUKE	13-	MK5190	MB5100	MK1190	MB1100
	390	Duke	KTMISDUKE	17-18	MK5190	-	MK1190	-

SM	690	Enduro R	KTM-690-LC4	10-13	MK5430	MB5010	MK1430	MB1010
SMC	690	Supermoto		08-12	MK5430	MB5010	MK1430	MB1010
SMC	690	Supermoto R	KTM690LC4	12-	MK5430	MB5010	MK1430	MB1010
	990	Superduke, R	KTM LC8EFI	04-	MK5330	MB5110	MK1330	MB1110
	1050	Adventure	KTM Adventure	15-	MK5430	MB5010	MK1430	MB1010
RC-8	1190	R	KTM-RC8	09-	MK5330	MB5110	MK1330	MB1110
	1290	Superduke R	KTM Superduke	14-	MK5330	MB5110	MK1330	MB1110
	1290	Superduke GT	KTM Superduke	16-	MK5330	MB5110	MK1330	MB1110
Moto Guzzi								
	850	Breva	LP	06-07	MK5030	MB5100	MK1030	MB1100
	850	Griso	LS	06-07	-	MB5100	-	MB1100
	850	Norge	LP	07-08	MK5030	MB5100	MK1030	MB1100
	940	Bellagio	LY	07-13	MK5030	MB5100	MK1030	MB1100
	1000	Le Mans IV	VV	88-91	-	MB5010	-	MB1010
	1100	Breva	LP	05-07	MK5030	MB5100	MK1030	MB1100
	1100	Griso	LS	06-09	MK5030	MB5100	MK1030	MB1100
V11	1100	Sport	KR	99-04	MK5030	MB5100	MK1030	MB1100
	1200	Breva	LP	06-07	MK5030	MB5100	MK1030	MB1100
	1200	Griso 8V	LS	07-	MK5030	MB5100	MK1030	MB1100
	1200	Norge	LP	06-	MK5030	MB5100	MK1030	MB1100
	1200	Norge GT 8V	LP	11-	MK5030	MB5100	MK1030	MB1100
	1200	Sport 4V	LP	08-	MK5030	MB5100	MK1030	MB1100
	1200	Stelvio	LZ	08-	MK5030	MB5100	MK1030	MB1100
	1400	California Custom	LV	13-	MK5030	MB5100	MK1030	MB1100
	1400	California Touring	LV	13-	MK5030	MB5100	MK1030	MB1100
Moto Morini								
	1200	Corsaro	ZLM01	05-	MK5030	MB5100	MK1030	MB1100
	1200	Corsaro Veloce	ZLM01	08-	MK5140	MB5110	MK1140	MB1110
	1200	Granpasso	ZLM03	08-	MK5140	MB5110	MK1140	MB1110
	1200	Scrambler	ZLM02	09-	MK5030	MB5100	MK1030	MB1100
	1200	Sport	ZLM02	08-	MK5030	MB5100	MK1030	MB1100
MV Agusta								
F3	675	Brutale	B310	12-	-	MB5110	-	MB1110
F3	675		F310	12-	-	MB5110	-	MB1110
	800	Brutale	B310	16-	-	MB5110	-	MB1110
	800	Brutale Dragster	B310	16-	-	MB5110	-	MB1110
	800	Brutale Dragster ABS	B3	17-	-	MB5110	-	MB1110
	800	Tourismo Veloce	B310	16-	-	MB5110	-	MB1110
	800	Rivale	S310	14-	-	MB5110	-	MB1110
F3	800		F310	14-	-	MB5110	-	MB1110
F4	1000	R, RR	F630	16-	MK5140	MB5110	MK1140	MB1110
F4	1000	R, RR	F511	10-12	MK5140	MB5110	MK1140	MB1110
	1090	Brutale RR	B5	10-	MK5140	MB5110	MK1140	MB1110
	1090	Brutale, Brutale R	B5	10-	MK5140	MB5110	MK1140	MB1110
MZ								
	1000	S	MZ1000	04-08	MK5120	MB5060	MK1120	MB1060
	1000	SF, SFX	MZ1000	05-08	MK5120	MB5060	MK1120	MB1060
	1000	ST, SN	MZ1000	05-08	MK5120	MB5060	MK1120	MB1060
Royal Enfield								
	500	Bullet EFI, Bullet Classic		17-18	MK5370	MB5210	MK1370	MB1210
	535	Continental GT		13-	MK5370	MB5100	MK1370	MB1100
Suzuki								
GSF	600	S Bandit	VVA8	00-04	-	MB5060	-	MB1060
GSR	600	A	VVB9	07-10	MK5080	MB5060	MK1080	MB1060
GSX-R	600		AD	97-00	MK5080	MB5060	MK1080	MB1060
GSX-R	600		VVBG	01-03	MK5080	MB5060	MK1080	MB1060
GSX-R	600		VVB2	04-05	MK5080	MB5070	MK1080	MB1070
GSX-R	600		VVCE	06-07	MK5090	MB5070	MK1090	MB1070
GSX-R	600		VVCV	08-10	MK5080	MB5060	MK1080	MB1060
GSX-R	600		C3	11-	MK5091	MB5070	MK1091	MB1070
GSX	600	F, FU	GN72B	88-97	MK5080	MB5060	MK1080	MB1060
DL	650	V-Strom	VVB1	04-	MK5080	MB5060	MK1080	MB1060

DL	650	A V-Strom	VVB1	07-11	MK5080	MB5060	MK1080	MB1060
DL	650	A V-Strom	C7	12-	MK5080	MB5060	MK1080	MB1060
DL	650	A V-Strom	WC70	17-	MK5080	MB5060	MK1080	MB1060
SFV	650	Gladius	WVCX	09-15	MK5080	MB5060	MK1080	MB1060
GSF	650	Bandit	VVB5	05-06	-	MB5060	-	MB1060
GSF	650	Bandit	VVCJ	07-08	MK5120	MB5060	MK1120	MB1060
GSF	650	Bandit	VWCZ	09-11	MK5120	MB5060	MK1120	MB1060
GSF	650	A Bandit	VVB5	05-06	-	MB5060	-	MB1060
GSF	650	A Bandit	VVCJ	07-08	MK5120	MB5060	MK1120	MB1060
GSF	650	A Bandit	VWCZ	09-11	MK5120	MB5060	MK1120	MB1060
GSF	650	S Bandit	VVB5	05-06	-	MB5060	-	MB1060
GSF	650	S Bandit	VVCJ	07-08	MK5120	MB5060	MK1120	MB1060
GSF	650	S Bandit	VWCZ	09-11	MK5120	MB5060	MK1120	MB1060
GSF	650	SA Bandit	VVB5	05-06	MK5120	MB5060	MK1120	MB1060
GSF	650	SA Bandit	VVB5	07-08	MK5120	MB5060	MK1120	MB1060
GSF	650	SA Bandit	VWCZ	09-11	MK5120	MB5060	MK1120	MB1060
SV	650	N	AV	99-02	MK5190	MB5060	MK1190	MB1060
SV	650	S	AV	99-02	MK5190	MB5060	MK1190	MB1060
SV	650	N	VVBY	03-09	MK5190	MB5060	MK1190	MB1060
SV	650	S	VVBY	03-09	MK5190	MB5060	MK1190	MB1060
SV	650	/ U	VVX0/VVX1	16-	MK5080	MB5200	MK1080	MB1200
GSR	750		C5	11-	MK5080	MB5060	MK1080	MB1060
GSX-R	750		GR7DB	96-99	MK5080	MB5060	MK1080	MB1060
GSX-R	750		VVBD	00-03	MK5080	MB5060	MK1080	MB1060
GSX-R	750		VVB3	04-05	MK5080	MB5070	MK1080	MB1070
GSX-R	750		VVCF	06-07	MK5090	MB5070	MK1090	MB1070
GSX-R	750		VVCW	08-10	MK5090	MB5070	MK1090	MB1070
GSX-R	750		C4	11-	MK5090	MB5070	MK1090	MB1070
GSX-S	750		WC50	17-	MK5080	MB5060	MK1080	MB1060
DL	1000	V-Strom	VVBS	02-09	MK5120	MB5060	MK1120	MB1060
DL	1000	V-Strom	DD	14-	MK5120	MB5200	MK1120	MB1200
DL	1000	V-Strom	WDD0	17-	MK5120	MB5060	MK1120	MB1060
GSX-R	1000		VVBL	01-02	MK5080	MB5060	MK1080	MB1060
GSX-R	1000		VVBZ	03-04	MK5080	MB5060	MK1080	MB1060
GSX-R	1000		VVB6	05-06	MK5090	MB5070	MK1090	MB1070
GSX-R	1000		VVCL	07-08	MK5120	MB5070	MK1120	MB1070
GSX-R	1000		VVCY	09-16	MK5090	MB5070	MK1090	MB1070
GSX-R	1000		WDM0	17-	MK5090	MB5072	MK1090	MB1072
GSX-S	1000	A	DG	15-16	MK5090	MB5072	MK1090	MB1072
GSX-S	1000	A	WDGO	17-	MK5092	MB5072	MK1092	MB1072
GSX-S	1000	FA	DG	15-16	MK5090	MB5072	MK1090	MB1072
GSX-S	1000	FA	WDGO	17-	MK5092	MB5072	MK1092	MB1072
SV	1000		VVBX	03-	MK5120	MB5060	MK1120	MB1060
SV	1000	S	VVBX	03-	MK5120	MB5060	MK1120	MB1060
TL	1000	S	AG	97-00	MK5080	MB5060	MK1080	MB1060
TL	1000	R	AM	98-01	MK5120	MB5060	MK1120	MB1060
GSF	1200	Bandit	GV75A	96-00	MK5200	MB5060	MK1200	MB1060
GSF	1200	Bandit, S Bandit	VVA9	01-05	MK5120	MB5060	MK1120	MB1060
GSF	1200	Bandit, S Bandit	VVCB	06-07	MK5120	MB5060	MK1120	MB1060
GSF	1250	A Bandit, SA Bandit	VVCH	07-12	MK5120	MB5060	MK1120	MB1060
GSX	1300	R Hayabusa	VVA1	99-07	MK5120	MB5060	MK1120	MB1060
GSX	1300	R Hayabusa	VVCK	08-12	MK5120	MB5060	MK1120	MB1060
GSX	1300	BK B King	VVCR	07-	-	MB5070	-	MB1070
GSX	1400		VVBN	02-	MK5120	MB5060	MK1120	MB1060
VL	1500	LC Intruder	AL	98-00	MK5130	MB5060	MK1130	MB1060
VL	1500	LC Intruder	VVAL	01-	MK5130	MB5060	MK1130	MB1060
Triumph								
	600	Speed Four	806LB	02-03	MK5160	MB5060	MK1160	MB1060
TT	600		806AD	00-	MK5160	MB5060	MK1160	MB1060
	650	Daytona	865LX	05	MK5150	MB5060	MK1150	MB1060
	660	Street Triple S ABS	HD02	17-	MK5150	MB5060	MK1150	MB1060
	660	Street Triple S ABS	HD03	17-	MK5150	MB5060	MK1150	MB1060
	675	Daytona	D67LC	06-	MK5150	MB5070	MK1150	MB1070

675	Street Triple	L67LR	13-	MK5150	MB5060	MK1150	MB1060	
675	Street Triple	D67LD	05-08	MK5150	MB5060	MK1150	MB1060	
675	Street Triple radial	D67LD	08-	MK5150	MB5070	MK1150	MB1070	
675	Street Triple S ABS	HD01	17-	MK5150	MB5060	MK1150	MB1060	
675	Street Triple RS ABS	HD01	17-	MK5150	MB5060	MK1150	MB1060	
800	Speedmaster	908ML	05-	MK5150	MB5060	MK1150	MB1060	
800	Tiger, XC	A08	11-	MK5150	MB5060	MK1150	MB1060	
800	TigerXC, XCX, XCA, XRT, XRX	C201	17-	MK5150	MB5060	MK1150	MB1060	
865	Bonneville America	986MK	07-	MK5150	MB5060	MK1150	MB1060	
865	Bonneville, T100	986MF	05-08	MK5150	MB5060	MK1150	MB1060	
865	Scrambler	986MG	06-	MK5150	MB5060	MK1150	MB1060	
865	Speedmaster	908ML	05-08	MK5150	MB5060	MK1150	MB1060	
865	Thruxton	986ME	04-07	MK5150	MB5060	MK1150	MB1060	
900	Bonneville T00 ABS,	DB01	16-17	MK5130	MB5060	MK1130	MB1060	
900	Bonneville T00 Black ABS	DB02	17-18	MK5130	MB5060	MK1130	MB1060	
900	Speed Triple	T300B	94-96	MK5130	MB5060	MK1130	MB1060	
900	Speed Triple	T509	97-98	MK5160	MB5060	MK1160	MB1060	
900	Sprint Sport	T300A	97-	MK5160	MB5060	MK1160	MB1060	
900	Street Cup ABS	DZ01	16-17	MK5130	MB5060	MK1130	MB1060	
900	Street Cup ABS	DZ02	17-18	MK5130	MB5060	MK1130	MB1060	
900	Street Scrambler ABS	DC01	17-	MK5130	MB5060	MK1130	MB1060	
900	Street Scrambler ABS	DC02	17-	MK5130	MB5060	MK1130	MB1060	
900	Street Twin ABS	DP01	16-	MK5130	MB5060	MK1130	MB1060	
900	Street Twin ABS	DP02	16-	MK5130	MB5060	MK1130	MB1060	
900	Tiger EFI	T709	99-01	MK5160	MB5060	MK1160	MB1060	
955	Daytona i	595SPP	99-	MK5160	MB5060	MK1160	MB1060	
955	Daytona i	T595	99-	MK5160	MB5060	MK1160	MB1060	
955	Daytona i	T595NSB	04-06	MK5150	MB5060	MK1150	MB1060	
955	Speed Triple 955 i	T595RPT	00-04	MK5160	MB5060	MK1160	MB1060	
955	Speed Triple EFI	T595N	02-04	MK5150	MB5060	MK1150	MB1060	
955	Sprint RS, ST	695AB	97-03	MK5160	MB5060	MK1160	MB1060	
955	Tiger i	709EN	02-06	MK5160	MB5060	MK1160	MB1060	
1050	Speed Triple axial	515NJ	05-07	MK5150	MB5060	MK1150	MB1060	
1050	Speed Triple radial	515NJ	08-12	MK5150	MB5070	MK1150	MB1070	
1050	Speed Triple radial	515NV	11-15	MK5150	MB5110	MK1150	MB1110	
1050	Speed Triple R,S	NN01	16-	MK5150	MB5110	MK1150	MB1110	
1050	Sprint GT	215ND	10-	MK5150	MB5060	MK1150	MB1060	
1050	Sprint ST	215NA	05-10	MK5150	MB5060	MK1150	MB1060	
1050	Tiger	115NG	07-13	MK5150	MB5060	MK1150	MB1060	
1050	Tiger Sport	115NG	07-13	MK5150	MB5060	MK1150	MB1060	
1050	Tiger Sport	NH01	16-17	MK5150	MB5060	MK1150	MB1060	
1200	Bonneville Bobber ABS	DV01	17-	MK5130	MB5060	MK1130	MB1060	
1200	Bonneville T 120 Black ABS	DU01	16-	MK5130	MB5060	MK1130	MB1060	
1200	Thruxton ABS	DE01	16-17	MK5130	MB5060	MK1130	MB1060	
1200	Thruxton ABS	DE01	16-17	MK5130	MB5060	MK1130	MB1060	
1200	Thruxton ABS	DE01	16-17	MK5130	MB5060	MK1130	MB1060	
1200	Tiger Explorer, XC	V13VG	12-	MK5130	MB5060	MK1130	MB1060	
2300	Rocket III	C23XB	06-	MK5150	MB5060	MK1150	MB1060	
2300	Rocket III Roadster ABS	C23XB	10-	MK5150	MB5060	MK1150	MB1060	
Yamaha								
YZF	300	R3	RH07	15-	-	MB5100	-	MB1100
XP	500	T-Max	SJ06	08-10	MK5300	MB5100	MK1300	MB1100
XP	530	T-Max	SJ09	12-	MK5300	MB5100	MK1300	MB1100
FZS	600	Fazer	RJ02	98-03	MK5310	MB5060	MK1310	MB1060
FZS	600	S Fazer	RJ02	00-01	MK5310	MB5060	MK1310	MB1060
FZ6	600	N Fazer	RJ07	04-06	MK5091	MB5100	MK1091	MB1100
FZ6	600	S Fazer	RJ07	04-06	MK5091	MB5100	MK1091	MB1100
FZ6	600	SA Fazer	RJ07	06	MK5091	MB5100	MK1091	MB1100
FZ6-S2	600	N	RJ14	07-09	MK5091	MB5100	MK1091	MB1100
FZ6-S2	600	NA	RJ14	07-10	MK5091	MB5100	MK1091	MB1100
FZ6-S2	600	S Fazer	RJ14	07-10	MK5091	MB5100	MK1091	MB1100
FZ6-S2	600	SA Fazer	RJ14	07-10	MK5091	MB5100	MK1091	MB1100
XJ6	600	F Diversion	RJ19	09-12	MK5090	MB5100	MK1090	MB1100

XJ6	600	FA Diversion	RJ19	09-12	MK5090	MB5100	MK1090	MB1100
XJ6	600	N Diversion	RJ19	09-12	MK5090	MB5100	MK1090	MB1100
XJ6	600	NA Diversion	RJ19	09-12	MK5090	MB5100	MK1090	MB1100
XJ6	600	S Diversion	RJ19	09-12	MK5090	MB5100	MK1090	MB1100
XJ6	600	SA Diversion	RJ19	09-12	MK5090	MB5100	MK1090	MB1100
XJ6	600	Diversion	RJ22	13-	MK5090	MB5100	MK1090	MB1100
XJ6	600	F Diversion	RJ22	13-	MK5090	MB5100	MK1090	MB1100
XJ6	600	FA Diversion	RJ22	13-	MK5090	MB5100	MK1090	MB1100
XJ6	600	N Diversion	RJ22	13-	MK5090	MB5100	MK1090	MB1100
XJ6	600	NA Diversion	RJ22	13-	MK5090	MB5100	MK1090	MB1100
XJ6	600	S Diversion	RJ22	13-	MK5090	MB5100	MK1090	MB1100
XJ6	600	SA Diversion	RJ22	13-	MK5090	MB5100	MK1090	MB1100
YZF	600	R6	RJ03	99-01	MK5091	MB5060	MK1091	MB1060
YZF	600	R6	RJ05	03	MK5091	MB5120	MK1091	MB1120
YZF	600	R6	RJ09	04	MK5091	MB5120	MK1091	MB1120
YZF	600	R6	RJ11	06-07	MK5091	MB5080	MK1091	MB1080
YZF	600	R6	RJ15	08-	MK5090	MB5080	MK1090	MB1080
YZF	600	R6	RJ27	17-	MK5090	MB5360	MK1090	MB1360
MT-03	660		RM02	06-09	MK5310	MB5100	MK1310	MB1100
MT-03	660		RM02/E	11-	MK5310	MB5100	MK1310	MB1100
MT-03	660		RM05	12-	MK5310	MB5100	MK1310	MB1100
XT	660	R	DM01	08-	-	MB5100	-	MB1100
XT	660	Z Ténére	DM02	08-12	-	MB5100	-	MB1100
XT	660	Z Ténére	DM04	15-	-	MB5100	-	MB1100
MT-07	700		RM04	14-16	MK5092	MB5100	MK1092	MB1100
MT-07	700	A	RM04	14-16	MK5090	MB5100	MK1090	MB1100
MT-07	700	A Tracer	RM14/RM15	16-	MK5090	MB5100	MK1090	MB1100
MT-07	700	A Moto Cage	RM17	16-17	MK5090	MB5100	MK1090	MB1100
MT-07	700	A Moto Cage	RM18	16-17	MK5090	MB5100	MK1090	MB1100
XSR	700	A	RM11	16-	MK5092	MB5100	MK1092	MB1100
XSR	700	A	RM12	16-	MK5092	MB5100	MK1092	MB1100
YZF	750	R/SP	4FM/4HD	93-	MK5130	MB5060	MK1130	MB1060
YZF	750	R/SP	4HS/4HR/4HO	93-	MK5130	MB5060	MK1130	MB1060
YZF	750	R	4HN	93-	MK5130	MB5060	MK1130	MB1060
YZF	750	SP	4HT	93-	MK5130	MB5060	MK1130	MB1060
FZ8	800	N, NA,	RN25	10-15	MK5090	MB5100	MK1090	MB1100
FZ8	800	S, SA Fazer	RN25	10-15	MK5090	MB5100	MK1090	MB1100
MT-09	850		RN29	14-16	MK5092	MB5100	MK1092	MB1100
MT-09	850	A	RN29	14-16	MK5092	MB5100	MK1092	MB1100
MT-09	850	A, A Tracer	RN43	15-	MK5092	MB5100	MK1092	MB1100
MT-09	850	A	RN43	17-	MK5092	MB5100	MK1092	MB1100
MT-09	850	SP A	RN43	17	MK5092	MB5100	MK1092	MB1100
MT-09	850	SP A	RN57	18-19	MK5092	MB5100	MK1092	MB1100
TDM	850		3VD	91-95	MK5310	MB5180	MK1310	MB1180
TDM	850		4CM	91-95	MK5310	MB5180	MK1310	MB1180
TDM	850		4TX	96-01	MK5310	MB5180	MK1310	MB1180
TDM	900		RN08	02-03	MK5310	MB5100	MK1310	MB1100
TDM	900		RN11	04-06	MK5310	MB5100	MK1310	MB1100
TDM	900		RN18	07-	MK5310	MB5100	MK1310	MB1100
TDM	900	A	RN11	05-06	MK5310	MB5100	MK1310	MB1100
TDM	900	A	RN18	07-10	MK5310	MB5100	MK1310	MB1100
XSR	900	60th. Anniversary	RN43	16-	MK5092	MB5100	MK1092	MB1100
MTN	1000	(MT-10)	RN45	16-	MK5500	MB5100	MK1500	MB1100
MTN	1000	(MT-10) SP	RN45	17-	MK5500	MB5100	MK1500	MB1100
FZR	1000	Genesis Exup	3LE	91-	MK5130	MB5060	MK1130	MB1060
FZS	1000	Fazer	RN06	01-04	MK5091	MB5060	MK1091	MB1060
FZS	1000	Fazer	RN14	04-05	MK5091	MB5060	MK1091	MB1060
FZ1	1000		RN16	06-	MK5091	MB5100	MK1091	MB1100
FZ1	1000	S Fazer	RN16	06-	MK5091	MB5100	MK1091	MB1100
YZF	1000	R Thunder Ace	4SV/4VF	96-01	MK5130	MB5060	MK1130	MB1060
YZF	1000	R Thunder Ace	4VD	96-01	MK5130	MB5060	MK1130	MB1060
YZF	1000	R1	RN01	98-99	MK5310	MB5060	M	

								
YZF	1000	R1	RN12	04-06	MK5091	MB5080	MK1091	MB1080
YZF	1000	R1	RN19	07-08	MK5091	MB5080	MK1091	MB1080
YZF	1000	R1	RN22	09-14	MK5090	MB5080	MK1090	MB1080
YZF	1000	R1	RN32	15-16	MK5090	MB5360	MK1090	MB1360
YZF	1000	R1M	RN32	15-16	MK5090	MB5360	MK1090	MB1360
YZF	1000	R1	RN49	17-	MK5090	MB5360	MK1090	MB1360
YZF	1000	R1M	RN49	17-	MK5090	MB5360	MK1090	MB1360
BT	1100	Bulldog	RP05	02-04	MK5080	MB5060	MK1080	MB1060
BT	1100	Bulldog	RP05	05-	MK5080	MB5100	MK1080	MB1100
FJ	1100		47E/47F	83-85	MK5130	MB5060	MK1130	MB1060
FJ	1200		1XJ/1YK,2NH	86-	MK5130	MB5060	MK1130	MB1060
FJ	1200		3CV/3CX/3GP	86-	MK5130	MB5060	MK1130	MB1060
FJ	1200		3CW/3CY	86-	MK5130	MB5060	MK1130	MB1060
FJ	1200		3YA/3CY	91-97	MK5130	MB5060	MK1130	MB1060
XJR	1200	SP	4PU	95-98	MK5130	MB5060	MK1130	MB1060
XT	1200	ZA	DP01	10-	MK5130	MB5100	MK1130	MB1100
XT	1200	ZE A	DP04	16-	MK5130	MB5100	MK1130	MB1100
XT	1200	ZE A	DP07	17-	MK5130	MB5100	MK1130	MB1100
FJR	1300		RP04	01-02	MK5130	MB5060	MK1130	MB1060
FJR	1300		RP08	0303	MK5130	MB5100	MK1130	MB1100
FJR	1300		RP11	04-05	MK5130	MB5100	MK1130	MB1100
FJR	1300		RP13	06-12	MK5130	MB5100	MK1130	MB1100
FJR	1300		RP23	13-15	MK5130	MB5100	MK1130	MB1100
FJR	1300		RP28	16-	MK5130	MB5100	MK1130	MB1100
XJR	1300		RP02	98-01	MK5130	MB5060	MK1130	MB1060
XJR	1300		RP06	02-03	MK5130	MB5060	MK1130	MB1060
XJR	1300		RP10	04-06	MK5130	MB5060	MK1130	MB1060
XJR	1300		RP19	07-16	MK5130	MB5100	MK1130	MB1100
MT-01	1700		RP12	05-06	MK5130	MB5080	MK1130	MB1080
MT-01	1700		RP18	07-12	MK5130	MB5080	MK1130	MB1080
XV-Y	1700	V-max	RP21	08-	MK5130	MB5080	MK1130	MB1080

BESTELNHINWEIS

Ihre gewünschte Farbe bestellen Sie, indem Sie der Bestellnummer das entsprechende Kürzel hinzufügen (Beispiel: MK5030**S** = Ausführung in Schwarz). **Die Sonderfarbe Gold bestellen Sie bitte per E-Mail.**

ORDER INFORMATION

You can order your desired colour by adding the corresponding abbreviation to the order number (example: MK5030**S** = version in black). **Please order the custom colour gold by e-mail.**

	S	schwarz	black
	T	titan	titanium
	C	silber	silver
	-	gold	gold



Höher-/ Tieferlegungen Jack-up/ lowering kits



Tieferlegungen Lowering kits

MIT ABE, KEINE EINTRAGUNG NÖTIG

- ermöglicht sicheren Stand durch mehr Bodenkontakt
- wie die Höherlegungen sind auch die Tieferlegungen aus Stahl oder Aluminium gefräst
- durch die Absenkung muss bei den meisten Modellen der Seitenständer gekürzt werden
- Zugstreben zur Tieferlegung sind länger als das Originalteil
- die Tieferlegung sollte ausschließlich durch eine Fachwerkstatt durchgeführt werden

WITH TÜV APPROVAL

- allows more secure stand through greater ground contact
- as with the jack-up kits, the lowering kits are also in stainless steel or milled aluminium
- for most models lowering means that the side stands must be shortened
- tie rods for lowering are longer than the original part
- the lowering should only be carried out by a specialist workshop



Vorher | Before



Nachher | After

Höherlegungen Jack-up kits

MIT ABE, KEINE EINTRAGUNG NÖTIG

- passgenaue Höherlegung des Hecks
- besseres Handling durch geänderte Fahrwerksgeometrie
- ermöglicht zwischen 25 mm bis 45 mm mehr Bodenfreiheit
- mehr Last auf dem Vorderrad und bessere Optik
- inkl. aussagefähiger Montageanleitung
- die Höherlegung sollte ausschließlich durch eine Fachwerkstatt durchgeführt werden

WITH TÜV APPROVAL

- precise raising of the rear end
- better handling through modified suspension geometry
- allows between 25 to 45 mm more ground clearance
- more load on the front wheel and improved appearance
- including detailed assembly instructions
- the raising should only be carried out by a specialist workshop

Typenübersicht Types summary



TYP | TYPE 01



TYP | TYPE 02



TYP | TYPE 03



TYP | TYPE 04

Mit Verlängerung für den Seitenständer | With stand extensions



TYP | TYPE 05

Mit Verlängerung für den Seitenständer | With stand extensions



TYP | TYPE 06

Mit abgedichteten Nadelhülsen, die über eine hohe Tragfähigkeit verfügen | With high load capacity sealed needle roller bearings



TYP | TYPE 07



TYP | TYPE 08



TYP | TYPE 09



TYP | TYPE 10

MATERIALINFO

Typ 01 + 03: hochwertiger Stahl, lasergeschnitten; alle anderen Typen: Aluminium, CNC-gefräst.

MATERIAL INFORMATION

Type 01 + 03: stainless steel, laser cut; all other models in aluminium, CNC-milled.



ACHTUNG!

Nach der Umbaumaßnahme ist es erforderlich, dass, je nach Beladung des Fahrzeugs, das Federstoßdämpfer-Management entsprechend angepasst wird, da es sonst zu Schäden am Fahrzeug bzw. an Fahrzeugteilen kommen kann.

ATTENTION!

Following conversion and depending on the bike load, the spring shock absorber system must be modified accordingly, otherwise damage to bike or bike components may occur.

◀ Messung der Höhenänderung lotrecht über der Hinterachse
Measuring the change in perpendicular height above the rear axle

Motorcycle		Year	Change	Typ	Info	Change	Typ	Info
			+ mm			- mm		
Aprilia								
650	Pegaso Trail		07-09	---	---	---	MCTL 134	30 01
750	Shiver	RA	07-16	---	---	---	MCTL 161	35 10 3) 6)
750	Dorsoduro	SM	08-13	---	---	---	MCTL 161	25 10 3) 6)
850	Mana	RC	07-10	---	---	---	MCTL 162	35 10 3) 6)
900	Shiver ABS	YB, KH	17-	---	---	---	MCTL 161	35 10 3) 6)
1000	Mille	ME	98-00	---	---	---	MCTL 123	30 01
1000	Mille, R	RP	01-03	MCHL 156	30 01	---	MCTL 143	30 01
1000	R	RR	06-10	MCHL 156	30 01	---	MCTL 143	30 01
1000	R Factory	RR	06-10	MCHL 156	30 01	---	MCTL 143	30 01
1000	Tuono	RP	03-05	MCHL 156	30 01	---	MCTL 143	30 01
1000	Tuono R	RR	06-08	MCHL 156	30 01	---	MCTL 143	30 01
1000	RSV4	RK	10-13	MCHL 156	30 01	---	MCTL 143	20 01
BMW								
310	R ABS	5R31	16-	MCHL 189	35 02 15)	---	MCTL 198	25 02 15)
310	GS ABS	5G31	17-	MCHL 189	40 02	---	MCTL 198	25 02
450	X		08-09	---	---	---	MCTL 156	18 10 3)
650	CS Scarver	K14	02-04	---	---	---	MCTL 144	25 03
650	CS Scarver	E650C	04-06	---	---	---	MCTL 144	25 03
650	GS	E650G	04-08	---	---	---	MCTL 127	25 09
650	GS	R13	00-03	---	---	---	MCTL 127	25 09
650	GS	E650G	09-	---	---	---	MCTL 127	25 09
650	Xcountry	E65X	07-10	---	---	---	MCTL 161	40 10 3)
650	Xmoto	E65X	07-10	---	---	---	MCTL 161	40 10 3)
850	GS	R21	99-00	MCHL 158	25 08	---	---	---
850	GS	BMW 259	97-99	MCHL 158	25 08	---	---	---
1100	GS	BMW 259	93-99	MCHL 158	25 08	---	---	---
1150	GS	R21	99-04	MCHL 158	25 08	---	---	---
1150	GS Advent.	R21	02-03	MCHL 158	25 08	---	---	---
1200	R	K12R	05-08	MCHL 167	25 01	---	MCTL 173	25 01
1200	R Sport	K12R	07-08	MCHL 167	25 01	---	MCTL 173	25 01
1200	S	K12S	05-09	MCHL 167	25 01	---	MCTL 173	25 01
1300	S, R, GT	K12S	09-11	MCHL 167	25 01	---	MCTL 173	25 01
1600	GT ABS	K16GT	12-16	---	---	---	MCTL 155	30 01
1600	GT ABS	2T16	16-	---	---	---	MCTL 155	30 01
1600	GT ABS	2T16r	16-	---	---	---	MCTL 155	30 01
1600	GTL ABS	K16GT	12-16	---	---	---	MCTL 155	30 01
1600	GTL ABS	2T16	16-	---	---	---	MCTL 155	30 01
1600	GTL ABS	2T16r	16-	---	---	---	MCTL 155	30 01
Cagiva								
650	Raptor	M2	01-08	MCHL 166	25 01	---	MCTL 167	25 01
1000	Raptor	M2	02-05	---	---	---	MCTL 167	25 01
Ducati								
620	Monster i.e.	M4	04-06	---	---	---	MCTL 161	30 10 3)
696	Monster	M5	08-12	---	---	---	MCTL 161	30 10 3)

Motorcycle		Year	Change	Typ	Info	Change	Typ	Info
			+ mm			- mm		
796	Monster	M5	10-12	---	---	---	MCTL 161	30 10 3)
1100	Monster, S	M5	08-11	---	---	---	MCTL 161	30 10 3)
1100	Monster EVO	M5	11-13	---	---	---	MCTL 161	30 10 3)
1200	Monster S,R	MA, MB	16-	---	---	---	MCTL 161	30 10 3)
Honda								
XL	125 Varadero	JC32	01-	---	---	---	MCTL 132	30 02 3)
XR	125 L	JD19	03-	---	---	---	MCTL 132	30 02 3)
CB	500 F	PC45	13-15	MCHL 174	25 01	---	MCTL 183	30 01
CB	500 FA	PC45	13-16	MCHL 174	25 01	---	MCTL 183	30 01
CB	500 F, FA	PC58	17-	MCHL 174	25 01	---	MCTL 183	30 01
CB	500 X, XA	PC46	13-	MCHL 174	25 01	---	MCTL 183	30 01
CB	500 X, XA	PC59	17-	MCHL 174	25 01	---	MCTL 183	30 01
CBF	500	PC39	04-	MCHL 116	30 02 4)	---	MCTL 118	30 02 4)
CBR	500 R, RA	PC44	13-16	MCHL 174	25 01	---	MCTL 183	30 01
CBR	500 R, RA	PC57	17-	MCHL 174	25 01	---	MCTL 183	30 01
CB	600 Hornet	PC34	98-01	MCHL 111	35 07 4)	---	MCTL 101	35 07 4)
CB	600 Hornet	PC36	02-06	MCHL 111	35 07 4)	---	MCTL 101	35 07 4)
CB	600 Hornet	PC41	07-08	MCHL 116	30 02 4)	---	MCTL 118	35 02 4)
CBF	600 N, S	PC38	04-07	MCHL 116	30 02 4)	---	MCTL 118	35 02 4)
CBF	600 N, S	PC43	08-10	MCHL 116	30 02 4)	---	MCTL 118	35 02 4)
CBF	600 NA, SA	PC38	04-07	MCHL 116	30 02 4)	---	MCTL 118	35 02 4)
CBF	600 NA, SA	PC43	08-10	MCHL 116	30 02 4)	---	MCTL 118	35 02 4)
CBR	600 F	PC25	91-94	---	---	---	MCTL 133	35 06
CBR	600 F	PC31	95-98	MCHL 118	30 06 5)	---	MCTL 133	35 06 5)
CBR	600 F	PC35	99-07	MCHL 117	30 03	---	MCTL 100	35 03
CBR	600 RA	PC40	09-16	MCHL 161	25 01	---	MCTL 145	25 01
CBR	600 RR	PC40	07-16	MCHL 161	25 01	---	MCTL 145	25 01
CBR	650 FA	RC96	17-	MCHL 116	30 02	---	MCTL 118	30 02 3)
NT	650 V Deauville	RC47	98-02	---	---	---	MCTL 118	25 02 3)
NC	700 D Integra, SD-DCT ABS	RC62	12-13	MCHL 168	35 03	---	MCTL 176	30 03
NC	700 S, SA, SD-DCT	RC61	12-14	MCHL 168	35 03	---	MCTL 176	30 03
NC	700 X	RC63	12-14	MCHL 168	35 03	---	MCTL 176	30 03
NT	700 V Deauville	RC52	06-09	---	---	---	MCTL 118	25 02 3)
NT	700 V Deauville	RC59	10-13	---	---	---	MCTL 118	25 02 3)
NC	750 D Integra, SD-DCT ABS	RC71	14-15	MCHL 168	35 03	---	MCTL 176	30 03
NC	750 D Integra, SD-DCT	RC89	16-	MCHL 168	35 03	---	MCTL 176	30 03
NC	750 S, SA, SD-DCT	RC70	14-15	MCHL 168	35 03	---	MCTL 176	30 03
NC	750 S, SA, SD-DCT	RC88	16-	MCHL 168	35 03	---	MCTL 176	30 03
NC	750 X, XA, XD-DCT	RC72	14-15	MCHL 168	35 03	---	MCTL 176	30 03
NC	750 X, XA, XD-DCT	RC90	16-	MCHL 168	35 03	---	MCTL 176	30 03
	750 X-ADV ABS	RC95	17-	MCHL 190	20 01	---	MCTL 199	35 01
VFR	800 A	RC46	02-13	MCHL 113	25 01	---	MCTL 134	25 01
VFR	800 X Crossrunner	RC60	11-14	MCHL 113	25 01	---	MCTL 134	25 01
VFR	800 X Crossrunner ABS	RC80	15-	MCHL 185	25 01	---	MCTL 194	25 01
VFR	800 X Crossrunner ABS	RC94	17-	MCHL 185	25 01	---	MCTL 194	25 01
VFR	800 F ABS	RC79	14-16	MCHL 186	20 01	---	MCTL 195	20 01
VFR	800 F ABS	RC93	17-	MCHL 186	20 01	---	MCTL 195	20 01
CB	900 F Hornet	SC48	02-03	---	---	---	MCTL 118	30 02 4)
CBR	900 RR Fireblade	SC28	92-95	MCHL 100	25 01	---	---	---
CBR	900 RR Fireblade	SC33	96-99	MCHL 101	35 01	---	---	---
CBR	900 RR Fireblade	SC44	00-01	MCHL 102	25 01	---	MCTL 116	25 01
CBR	954 RR Fireblade	SC50	02-03	---	25 01	---	MCTL 123	25 01
CBR	1000 RR Fireblade	SC57	04-07	MCHL 115	30 06	---	MCTL 181	35 06
CBF	1000	SC58	06-10	MCHL 116	30 02 4)	---	---	---
CBR	1000 RA	SC59	09-16	MCHL 162	30 01	---	MCTL 147	40 01
CBR	1000 RR	SC59	08-16	MCHL 162	30 01	---	MCTL 147	40 01
VTR	1000 SP 1	SC45	00-01	MCHL 157	30 07 3)	---	---	---
VTR	1000 SP 2	SC45	02-07	MCHL 157	30 07 3)	---	---	---
XL	1000 V Varadero	SD01	99-00	MCHL 114	30 01	---	MCTL 135	35 01
XL	1000 V, VA Varadero	SD02	01-10	MCHL 114	30 01	---	MCTL 102	35 01
XL	1000 V, VA Varadero	SD03	11-13	MCHL 114	30 01	---	MCTL 102	35 01
CB	1100 SF X-11	SC42	00-03	MCHL 116	25 02 4)	---	MCTL 118	35 02 4)
CBR	1100 XX Blackbird Dual CBS	SC35	99-08	MCHL 116	30 02 4)	---	MCTL 117	30 01
VFR	1200 F ABS	SC63	10-16	MCHL 165	30 01	---	MCTL 172	25 01
VFR	1200 X, XL Crosstourer ABS	SC70	12-15	MCHL 171	35 01	---	MCTL 179	30 01
VFR	1200 XD, XDL Crosstourer ABS	SC70	12-15	MCHL 171	35 01	---	MCTL 179	30 01

							Typ				Typ	
				+ mm					- mm			
VFR	1200	X, XL Crosstourer ABS	SC76	16-	MCHL 171	35	01		MCTL 179	30	01	
VFR	1200	XD, XDL Crosstourer ABS	SC76	16-	MCHL 171	35	01		MCTL 179	30	01	
Husqvarna												
	401	Vitpilen	HQV401	17-	MCHL 181	20	03		MCTL 188	30	03	
	900	Nuda i.e.	A7	12-13	---	---	---		MCTL 161	35	10	3) 6)
	900	Nuda R i.e.	A7	12-13	---	---	---		MCTL 162	35	10	3) 6)
Kawasaki												
Z	125		BR125K	18-	MCHL 122	40	03		MCTL 126	35	03	
	125	Ninja		18-	MCHL 199	30	03		MCTL 126	30	03	
EX	250	Ninja R	EX250K	07-14	MCHL 105	30	03		MCTL 139	25	03	
KLX	250		LX250S	09-	MCHL 191	25	03		MCTL 200	30	03	
	300	Versys-X ABS	LE300G	17-	MCHL 192	20	03	15)	MCTL 201	30	03	
EX	300	Ninja R	EX300A(A)	13-16	MCHL 105	30	03		MCTL 184	25	03	8)
Z	300	, ABS	ER300A	15-16	MCHL 143	30	03		MCTL 184	35	03	8)
Z	400	Ninja	3KAEX	18-	MCHL 193	30	03	13) 15)	MCTL 202	30	03	12) 13)
GPZ	500	S	EX500D (E)	94-	---	---	---		MCTL 112	40	03	
ZX-6R	600	Ninja	ZX600F	95-97	MCHL 110	30	03		MCTL 103	35	03	
ZX-6R	600	Ninja	ZX600G(G,H)	98-99	MCHL 110	30	03		MCTL 124	35	03	
ZX-6R	600	Ninja	ZX600J	00-02	MCHL 110	30	03		MCTL 124	35	03	
ZX-6R	600	Ninja	ZX600P	06-08	MCHL 110	30	03		MCTL 103	40	03	
ZX-6R	600	Ninja	ZX600R	09-16	---	---	---		MCTL 119	40	03	
ZX-6RR	600	Ninja	ZX600K(K,M)	03-04	---	---	---		MCTL 124	35	03	
ZX-6RR	600	Ninja	ZX600N	05-06	MCHL 110	30	03		MCTL 103	35	03	
ZX-6R	636	Ninja	ZX636A	02	MCHL 110	30	03		MCTL 124	35	03	
ZX-6R	636	Ninja	ZX636B	03-04	MCHL 110	30	03		MCTL 124	35	03	
ZX-6R	636	Ninja	ZX636C	05-06	MCHL 110	30	03		MCTL 103	35	03	
ZX-6R	636	Ninja	ZX636E	13-16	MCHL 110	25	03		MCTL 103	30	03	
ER-6	650	F	EX650A	05-08	---	---	---		MCTL 125	25	10	3)
ER-6	650	N	ER650A	05-08	---	---	---		MCTL 125	25	10	3)
	650	Ninja ABS	EX650K	17-	MCHL 188	30	01	14)	MCTL 197	30	01	14)
	650	Ninja KRT Edition ABS	EX650K	17-	MCHL 188	30	01	14)	MCTL 197	30	01	14)
Z	650	Versys LT	ER650H/AH2	17-	MCHL 188	30	01		MCTL 197	30	01	
Z	750	, S	ZR750J(J,K)	04-06	MCHL 110	25	03		MCTL 103	25	03	
Z	750	L	ZR750L	07-10	MCHL 123	30	03		MCTL 106	30	03	
Z	750	R, ABS	ZR750N(N,P)	11-14	MCHL 123	25	03		MCTL 106	25	03	
ZX-7R	750	Ninja	ZX750N (N,P)	96-	MCHL 110	25	03		---	---	---	
Z	800		ZR800A/C	12-	MCHL 120	35	03		MCTL 103	35	03	
Z	800	e-version, ABS	ZR800C (C) (D)	13-16	MCHL 120	35	03		MCTL 103	35	03	
Z	800	e Version Special Edition ABS	ZR800F(F)	16-	MCHL 120	35	03		MCTL 103	35	03	
ZX-9 R	900	Ninja	ZX900E (E,F)	01-04	MCHL 110	30	03		MCTL 124	35	03	
ZX-9 R	900	Ninja	ZX900C (C,D)	98-00	MCHL 110	30	03		MCTL 124	35	03	
Z	900	ABS	ZR900B	17-	MCHL 183	30	01		MCTL 191	30	01	
Z	900	RS, RS Cafe ABS	ZR900C	18-	MCHL 183	30	01		MCTL 191	30	01	
KLV	1000		WVBS	02-06	MCHL 144	25	03		MCTL 111	20	03	
KLZ	1000	Versys	LZT00A	12-14	MCHL 164	35	01		MCTL 166	20	01	
KLZ	1000	Versys	LZT00B	15-16	MCHL 164	25	01		MCTL 166	25	01	
KLZ	1000	Versys	LZT00B	17-	MCHL 164	25	01		MCTL 166	25	01	
Z	1000	SX	ZXT00G(H)	11-13	MCHL 164	25	01		MCTL 166	30	01	
Z	1000	SX	ZXT00L(LA)	14-16	MCHL 164	25	01		MCTL 166	30	01	
Z	1000	SX ABS	ZXT00W	17-	MCHL 169	30	01		MCTL 177	25	01	9)
Z	1000		ZRT00A(A)	03-06	MCHL 110	25	03		MCTL 103	30	03	
Z	1000		ZRT00B (B,C)	07-09	MCHL 120	30	03		MCTL 106	30	03	
Z	1000		ZRT00D (D,E)	10-13	MCHL 164	30	01		MCTL 166	30	01	
Z	1000		ZRT00F(F,G)	14-16	MCHL 169	30	01		MCTL 177	30	01	9)
Z	1000		ZRT00H(H)	17-	MCHL 169	30	01		MCTL 177	25	01	9)
ZX-10R	1000	Ninja	ZXT00C	04-05	MCHL 110	30	03		MCTL 124	30	03	
ZX-10R	1000	Ninja	ZXT00D	06-07	MCHL 110	30	03		MCTL 141	25	03	
ZX-10R	1000	Ninja	ZXT00E	08-09	MCHL 163	25	03		MCTL 150	25	03	
ZX-10R	1000	Ninja	ZXT00F	10	MCHL 163	25	03		MCTL 150	25	03	
ZX-10R	1000	Ninja ABS	ZXT00S	16-	MCHL 187	25	01		MCTL 196	25	01	
ZX-10R	1000	Ninja KRT Replica ABS	ZXT00S	16-	MCHL 187	25	01		MCTL 196	25	01	
ZX-10RR	1000	Ninja ABS	ZXT00S	16-	MCHL 187	25	01		MCTL 196	25	01	
	1000	Ninja H2 SX ABS	ZXT00X	18-	MCHL 195	25	03	15)	MCTL 204	25	03	
ZX-12R	1200	Ninja	ZXT20A(A)	01-02	MCHL 110	30	03		MCTL 119	30	03	
ZX-12R	1200	Ninja	ZXT20A(B)	02-06	MCHL 110	30	03		MCTL 119	30	03	

							Typ				Typ	
				+ mm					- mm			
KTM												
RC	125	ABS	KTM-IS-RC	14-	MCHL 172	20	02	3)	MCTL 180	30	02	3)
	125	Duke 4T	KTM-IS-Duke	11-12	MCHL 172	30	02	3)	MCTL 180	40	02	3)
	125	Duke 4T ABS	KTM-IS-Duke	13-	MCHL 172	30	02	3)	MCTL 180	40	02	3)
	125	Duke 4T ABS	KTM-IS-Duke	17-	MCHL 181	20	02	3)	MCTL 188	25	02	3)
	200	Duke	KTM-IS-Duke	12	MCHL 172	30	02	3)	MCTL 180	40	02	3)
	200	Duke ABS	KTM-IS-Duke	13-	MCHL 172	30	02	3)	MCTL 180	40	02	3)
	350	Freeride 4T	KTM-Freeride	12-	---	---	---		MCTL 162	25	10	3)
RC	390	Duke	KTM-IS-RC	14-15	---	---	---		MCTL 180	30	02	3)
RC	390	Duke	KTM-IS-RC	17-	---	---	---		MCTL 189	30	02	3)
	390	Duke 4T	KTM-IS-Duke	13-	MCHL 172	30	02	3)	MCTL 180	40	02	3)
	390	Duke 4T ABS	KTM-IS-Duke	17-	MCHL 181	20	02	3)	MCTL 188	30	02	3)
SC	620	LC4 Supermoto	KTM-4T-SC	98-01	MCHL 154	25	03		MCTL 130	25	03	
SXC	625		KTM-4T-EGS	03-06	MCHL 154	25	03		MCTL 130	25	03	
	640	Duke II	KTM DK II	99-07	---	---	---		MCTL 130	25	03	
	640	LC4-E Supermoto	KTM-4T-EGS	98-06	MCHL 154	25	03		MCTL 130	25	03	
EXC	660	LC4 Rally	KTM Rally	99	MCHL 154	25	03		MCTL 130	25	03	
SMC	660	Supermoto	KTM-4T-EGS	03-06	MCHL 154	25	03		MCTL 130	25	03	
	690	Duke	KTM 690 Duke	12-15	MCHL 196	25	02		MCTL 206	30	02	
	690	Duke	KTM 690 Duke	16-	MCHL 196	25	02		MCTL 206	30	02	
SM	690	Supermoto	KTM-LC4	07-10	---	---	---		MCTL 162	20	10	3)
SMC	690	Supermoto	KTM-690-LC4	08-11	---	---	---		MCTL 162	35	10	3)
SMC	690	Supermoto R	KTM-690-LC4	12-13	---	---	---		MCTL 162	35	10	3)
	690	Duke	KTM Duke	08-11	---	---	---		MCTL 162	20	10	3)
	690	Duke R	KTM Duke	10-	---	---	---		MCTL 162	20	10	3)
	690	Duke R ABS	KTM 690 Duke	16-	---	---	---		MCTL 162	20	10	3)
	690	Enduro	690 LC4	08-11	---	---	---		MCTL 162	35	10	3)
	690	Enduro R	690 LC4	09-16	---	---	---		MCTL 162	35	10	3)
	790	Duke ABS		18-	MCHL 197	30	02	15)	MCTL 207	35	02	12)
SMR	990	Supermoto R ABS	KTM-LC8-SM	12-13	---	---	---		MCTL 162	10	10	3)
SMT	990	Supermoto T ABS	KTM-LC8-SM	11-13	---	---	---		MCTL 162	35	10	3)
	990	Superduke	KTM-LC8-EFI	05-11	---	---	---		MCTL 162	25	10	3)
	990	Superduke R	KTM-LC8-EFI	07-13	---	---	---		MCTL 162	25	10	3)
	1050	Adventure ABS	KTM Adventure	15-	---	---	---		MCTL 162	25	10	3)
	1090	Adventure ABS	KTM Adventure	17-	---	---	---		MCTL 162	25	10	3)
	1090	Adventure R ABS	KTM Adventure	17-	---	---	---		MCTL 162	25	10	3)
MZ/MUZ												
	660	Baghira	MKZ660E	02-06					MCTL 148	30	03	
	660	Mastiff	MKZ660E	02-07					MCTL 148	30	03	
Suzuki												
GS	500	E/EU	GM51B	89-00	MCHL 110	25	03		MCTL 109	40	03	1)
GS	500	E/EU	WVBK	01-	MCHL 110	25	03		MCTL 109	40	03	1)
GS	500	E/EU	BK	03-06	MCHL 110	25	03		MCTL 109	40	03	1)
GSF	600	Bandit	GN77B	95-99	MCHL 120	35	03		MCTL 106	35	03	6)
GSF	600	Bandit, S	WVA8	00-04	MCHL 120	35	03		MCTL 106	30	03	
GSR	600		WVB9	06-10	MCHL 105	25	03		MCTL 114	30		

Motorcycle				Hourglass	Link	Spring	Typ	Info	Link	Spring	Typ	Info
				+ mm					- mm			
GSF	650	S Bandit	WVCZ	09-12	MCHL 120	35	03		MCTL 106	30	03	
GSX	650	F	WVCJ	08-13	MCHL 120	35	03		MCTL 106	30	03	
GSX	650	FA	WVCJ	08-16	MCHL 120	35	03		MCTL 106	30	03	
SFV	650	Gladius, A Gladius	WVCX	09-16	MCHL 106	25	03		MCTL 154	25	03	
SV	650		AV	99-02	MCHL 124	30	03		MCTL 107	30	03	
SV	650		WVBY	03-07	MCHL 144	25	03		MCTL 108	30	03	
SV	650	ABS	WCX0/WCX1	16-	MCHL 106	20	03		MCTL 154	30	03	
SV	650	X ABS		18-	MCHL 106	20	03		---	---	---	
GSR	750		C5	11-15	MCHL 127	35	03		MCTL 174	35	03	
GSR	750	A	C5	12-16	MCHL 127	35	03		MCTL 174	35	03	
GSX	750	F	AK	99-02	---	---	---		MCTL 104	30	03	
GSX	750	F	WVAK	03-06	---	---	---		MCTL 104	30	03	
GSX-R	750		GR77B	88-89	MCHL 125	35	03		---	---	---	
GSX-R	750		GR7AB	90-91	MCHL 125	35	03		---	---	---	
GSX-R	750		GR7BB	92-95	MCHL 126	25	03		MCTL 162	25	10	3)
GSX-R	750		GR7BC	92-95	MCHL 126	25	03		MCTL 162	25	10	3)
GSX-R	750		GR7DB	96-99	MCHL 122	25	03		MCTL 111	25	03	
GSX-R	750		WVBD	00-03	MCHL 123	25	03		MCTL 106	30	03	
GSX-R	750		WVB3	04-05	MCHL 123	25	03		MCTL 106	30	03	
GSX-R	750		WVCF	06-07	MCHL 137	25	07	3)	MCTL 122	25	07	3)
GSX-R	750		WVCW	08-10	MCHL 137	25	07	3)	MCTL 122	25	07	3)
GSX-R	750		C4	11-16	MCHL 137	25	07	3)	MCTL 122	25	07	3)
GSX-S	750	A, AZ	WC50	17-	MCHL 127	35	03		MCTL 174	45	03	
RF	900	R	GT73B	94-97	MCHL 140	30	03		MCTL 106	30	03	
DL	1000	V-Strom	WVBS	02-09	MCHL 144	25	03		MCTL 111	20	03	
DL	1000	A V-Strom	DD	14-16	MCHL 173	30	01		MCTL 155	30	01	
DL	1000	V-Strom	WDD0	17-	MCHL 173	30	01		MCTL 155	30	01	
GSX-R	1000		WVBL	01-02	MCHL 123	25	03		MCTL 106	30	03	
GSX-R	1000		WVBZ	03-04	MCHL 123	25	03		MCTL 106	30	03	
GSX-R	1000		WVB6	05-06	MCHL 120	25	03		MCTL 109	30	03	
GSX-R	1000		WVCL	07-08	MCHL 137	25	07	3)	MCTL 122	15	07	3)
GSX-R	1000		WVCY	09-16	MCHL 107	30	01		MCTL 155	30	01	
GSX-R	1000	A	WDM0	17-	MCHL 182	30	01		MCTL 190	30	01	
GSX-R	1000	RA	WDM0	17-	MCHL 182	30	01		MCTL 190	30	01	
GSX-S	1000	A, FA	DG	15-16	MCHL 178	25	01		MCTL 179	25	01	
GSX-S	1000	A, FA	WDG0	17-	MCHL 178	25	01		MCTL 179	25	01	
GSX-R	1100		GV73C	89-92	MCHL 125	35	03		---	---	---	
GSX-R	1100		GU75C	95-96	MCHL 126	30	03		MCTL 162	25	10	3)
GSF	1200	Bandit	GV75A	96-00	MCHL 110	35	03		MCTL 109	35	03	
GSF	1200	Bandit	WVA9	01-05	MCHL 110	35	03		MCTL 109	35	03	
GSF	1200	Bandit	WVCB	06	MCHL 110	35	03		MCTL 109	35	03	
GSX	1200		A3	99-01	MCHL 129	35	04		---	---	---	
GSF	1250	Bandit	WVCH	07	MCHL 110	35	03		MCTL 109	35	03	
GSX	1250	F, FA	WVCH	10-17	MCHL 110	35	03		MCTL 109	35	03	
GSX	1300	BK B-King	WVCR	07-10	MCHL 105	30	03		MCTL 112	30	03	
GSX-R	1300	R Hayabusa	WVA1	99-05	MCHL 131	30	03		MCTL 148	30	03	
GSX-R	1300	R Hayabusa	WVA1	06-07	MCHL 131	30	03		MCTL 148	30	03	
GSX-R	1300	R Hayabusa	WVCK	08-12	MCHL 131	30	03		MCTL 148	30	03	
GSX	1400		WVBN	02-06	MCHL 129	35	04		---	---	---	
Triumph												
	675	Daytona	D67LC	06-11	MCHL 139	25	01		MCTL 136	25	01	
	675	Daytona	H67	12-13	MCHL 139	25	01		MCTL 136	25	01	
	675	Daytona R	D67LC	11	MCHL 139	25	01		MCTL 136	25	01	
	675	Daytona R	H67	12-13	MCHL 139	25	01		MCTL 136	25	01	
	675	Street Triple	D67LD	08-12	MCHL 139	25	01		MCTL 136	30	01	
	675	Street Triple R	D67LD	09-12	MCHL 139	25	01		MCTL 136	30	01	
	675	Street Triple	L67LR	13-17	MCHL 139	25	01		MCTL 136	30	01	
	675	Street Triple R	L67LR	13-17	MCHL 139	25	01		MCTL 136	30	01	
	675	Street Triple Rx ABS	L67LR	15-17	MCHL 139	25	01		MCTL 136	30	01	
	765	Street Triple R ABS	HD01	17-	MCHL 198	25	03		MCTL 208	35	03	
	765	Street Triple RS ABS	HD01	17-	MCHL 198	25	03		MCTL 208	35	03	
	765	Street Triple S ABS	HD01	17-	MCHL 198	25	03		MCTL 208	35	03	
	800	Tiger	A08	11-14	MCHL 122	30	03		MCTL 126	35	03	
	800	Tiger XC	A08	11-14	MCHL 122	30	03		MCTL 126	35	03	
	800	Tiger XR ABS	AO082	15-16	MCHL 180	30	03		MCTL 186	30	03	
	800	Tiger XCX ABS	AO082	15-16	MCHL 180	30	03		MCTL 186	30	03	

Motorcycle				Hourglass	Link	Spring	Typ	Info	Link	Spring	Typ	Info
				+ mm					- mm			
	800	Tiger XR ABS	AO08	17-	MCHL 180	30	03		MCTL 186	30	03	
	800	Tiger XCX ABS	AO08	17-	MCHL 180	30	03		MCTL 186	30	03	
	800	Tiger XTR ABS	AO08	17-	MCHL 180	30	03		MCTL 186	30	03	
	900	Legend	T309RT	99-01	MCHL 120	25	03		MCTL 141	30	03	
	1050	Speed Triple	515NV	11-15	MCHL 167	35	01		MCTL 159	25	01	
	1050	Speed Triple	NN01	16-	MCHL 167	35	01		MCTL 159	25	01	
	1050	Tiger	115NG	07-13	MCHL 167	25	01		MCTL 171	30	01	
	1050	Tiger Sport	115NG	13-15	MCHL 167	25	01		MCTL 171	25	01	
	1050	Tiger Sport	115NG	16-	MCHL 167	25	01		MCTL 171	25	01	
	1200	Tiger Explorer XR ABS	V201	15-	MCHL 184	30	03		MCTL 192	35	03	
	1200	Tiger Explorer XR ABS	V201	15-	MCHL 184	30	03		MCTL 192	35	03	
	1200	Tiger Explorer XC ABS	V201	15-	MCHL 184	30	03		MCTL 192	35	03	
	1200	Tiger Explorer ABS	V13VG	12-15	MCHL 184	30	03		MCTL 192	35	03	
	1200	Trophy SE ABS	V13VH	13-	MCHL 131	30	03		MCTL 111	40	03	
Yamaha												
DT	125	R, RH, RN	4BL	95-	---	---	---		MCTL 137	25	03	
DT	125	RE, X	DE06	05-06	---	---	---		MCTL 137	25	03	
MT	125		RE11	15-16	MCHL 175	25	03		MCTL 185	30	03	7) 10)
MT	125		RE29	17-	MCHL 175	25	03		MCTL 185	30	03	7) 10)
YZF	125	R	RE06	08-13	MCHL 177	30	03		MCTL 149	30	03	7)
YZF	125	A	RE11	14-16	MCHL 175	25	03		MCTL 185	30	03	7) 10)
YZF	125	R	RE11	14-16	MCHL 175	35	03		MCTL 185	30	03	7) 10)
YZF	125	R	RE29	17-	MCHL 175	35	03		MCTL 185	30	03	7) 10)
FZ6	600	N	RJ07	04-06	MCHL 119	35	02	3)	MCTL 138	35	02	3)
FZ6	600	NA	RJ14	07-08	MCHL 119	35	02	3)	MCTL 138	35	02	3)
FZ6	600	S Fazer	RJ07	04-06	MCHL 119	35	02	3)	MCTL 138	35	02	3)
FZ6	600	SA Fazer	RJ14	07-08	MCHL 119	35	02	3)	MCTL 138	35	02	3)
FZ6-S2	600	N, NA	RJ14	07-10	MCHL 119	35	02	3)	MCTL 138	35	02	3)
FZ6-S2	600	S, SA Fazer	RJ14	07-10	MCHL 119	35	02	3)	MCTL 138	35	02	3)
FZR	600	H Genesis	3HE	88-93	MCHL 122	30	03		---	---	---	
FZR	600	M, N Genesis	3RG,3RH	88-93	MCHL 122	30	03		---	---	---	
FZR	600	R Genesis	4JH,4MH	94-95	MCHL 140	30	03		MCTL 114	40	03	
FZS	600	Fazer	RJ02	98-03	MCHL 141	35	03		MCTL 111	35	03	
XJ6	600	F, FA Diversion	RJ19	09-12	---	---	---		MCTL 156	25	10	3)
XJ6	600	N, NA	RJ19	09-12	---	---	---		MCTL 156	25	10	3)
XJ6	600	S, SA Diversion	RJ19	09-12	---	---	---		MCTL 156	25	10	3)
XJ6	600	F, FA Diversion	RJ22	12-16	---	---	---		MCTL 156	25	10	3)
XJ6	600	N, NA	RJ22	12-16	---	---	---		MCTL 156	25	10	3)
XJ6	600	S, SA Diversion	RJ22	12-16	---	---	---		MCTL 156	25	10	3)
YZF	600	R6	RJ03	99-02	MCHL 142	25	06		---	---	---	
YZF	600	R6	RJ05	03-04	MCHL 152	25	06		MCTL 120	30	06	
YZF	600	R6	RJ09	05-06	MCHL 152	25	06		MCTL 120	30	06	
YZF	600	R6	RJ11	06-07	MCHL 143	25	03		MCTL 126	30	03	
YZF	600	R6	RJ15	08-16	MCHL 143	25	03		MCTL 126	30	03	
YZF	600	R6 ABS	RJ27	08-16	MCHL 143	25	03		MCTL 126	30	03	
YZF	600	R Thunder Cat	4CV, 4WE	96-99	MCHL 140	30	03		MCTL 184	30	03	
YZF	600	R Thunder Cat	4TV,4WD	96-99	MCHL 140	30	03		MCTL 184	30	03	
MT-03	660		RM02	06-09	MCHL 136	30	02	3)	MCTL 152	25	02	3)
SZR	660		4SU	95-98	---	---	---		MCTL 108	30	03	
XT	660	R	DM01	04-16	MCHL 159	35	03		MCTL 140	30	03	
XT	660	X	DM01	04-16	MCHL 159	35	03		MCTL 140	30	03	
XT	660	Z Ténéré	DM02	08-12	MCHL 131	30	03		MCTL 165	35	03	
XT	660	Z, ZA Ténéré	DM04	13-16	MCHL 131	30	03		MCTL 165	35	03	
MT-07	700	, A	RM04	14-16	---	---	---		MCTL 125	25	10	
MT-07	700	Moto Cage	RM04	14-16	---	---						

🏍️				⌚	🔗	🔗 + mm	Typ	📄	🔗	🔗 - mm	Typ	📄
MT-09	850	A Tracer	RN43	17-	MCHL 176	25	03		MCTL 178	25	03	11)
TRX	850		4UN	96-99	MCHL 110	30	03		---	---	---	
TDM	900		RN08	02-03	---	---	---		MCTL 139	35	03	
TDM	900		RN11	04-06	---	---	---		MCTL 139	35	03	
TDM	900		RN18	07-11	---	---	---		MCTL 139	35	03	
XJ	900	Diversion	4KM	95-03	---	---	---		MCTL 111	35	03	
XJ	900	Diversion	4PR	95-03	---	---	---		MCTL 111	35	03	
FZ-1	1000	N, S Fazer	RN16	06-15	MCHL 149	30	01		MCTL 115	25	01	
FZ-1	1000	NA, SA Fazer	RN16	07-15	MCHL 149	30	01		MCTL 115	25	01	
FZR	1000	Genesis	2LA	87-88	MCHL 122	30	03		---	---	---	
FZR	1000	Genesis Exup	3LE, 3LH, 3LF, 3GM	89-95	MCHL 143	45	03		MCTL 184	30	03	
FZS	1000	Fazer	RN06	01-04	MCHL 144	30	03		MCTL 111	25	03	
FZS	1000	Fazer	RN14	04-05	MCHL 144	30	03		MCTL 111	25	03	
GTS	1000		4BH	93-95	---	---	---		MCTL 106	25	03	
YZF	1000	R1	RN01	98-99	MCHL 146	25	06		MCTL 120	30	06	
YZF	1000	R1	RN04	00-01	MCHL 146	25	06		MCTL 120	30	06	
YZF	1000	R1	RN09	02-03	MCHL 152	25	06		MCTL 120	30	06	
YZF	1000	R1	RN12	04-05	MCHL 134	25	01		MCTL 145	30	01	
YZF	1000	R1	RN12	06	MCHL 134	20	01		---	---	---	
YZF	1000	R1	RN19	07-08	MCHL 160	25	06		MCTL 153	25	06	
YZF	1000	R1	RN22	09-14	MCHL 146	35	06		MCTL 157	30	06	
YZF	1000	R1 ABS, R1M ABS	RN32	15-16	MCHL 144	25	03		MCTL 111	25	03	
YZF	1000	R1 ABS, R1M ABS	RN49	17-	MCHL 144	25	03		MCTL 111	25	03	
YZF	1000	Thunderace	4SV, 4VF, 4VD	95-02	MCHL 105	25	03		MCTL 184	35	03	
BT	1100	Bulldog	RP04/RP05	02-06	MCHL 131	30	03		MCTL 128	30	03	
XJR	1200		4PU	94-98	MCHL 145	40	05		---	---	---	
XT	1200	ZA	DP01	10-13	MCHL 170	35	03		MCTL 164	35	03	
XT	1200	ZA	DP04	14-16	MCHL 170	35	03		MCTL 164	35	03	
XT	1200	ZE	DP04	14-	MCHL 179	25	03		MCTL 187	25	03	
FJR	1300		RP04	01-02	MCHL 143	30	03		MCTL 112	30	03	
FJR	1300	A	RP08	03	MCHL 143	30	03		MCTL 112	30	03	
FJR	1300	A	RP11	04-05	MCHL 143	30	03		MCTL 112	30	03	
FJR	1300	A, AS	RP13	06-12	MCHL 163	25	03		MCTL 150	25	03	
FJR	1300	A, AS, AE	RP23	13-15	MCHL 163	25	03		MCTL 150	25	03	
XJR	1300		RP02	98-01	MCHL 145	40	05		---	---	---	
XJR	1300		RP06	02-03	MCHL 145	40	05		---	---	---	
XJR	1300		RP10	04-06	MCHL 145	40	05		---	---	---	
XJR	1300		RP19	07-16	MCHL 145	40	05		---	---	---	
MT-01	1670		RP12	05-06	---	---	---		MCTL 151	25	10	3)
MT-01	1670		RP18	07-12	---	---	---		MCTL 151	25	10	3)

- | | |
|--|--|
| 1) Hauptständer muss entfernt werden | 1) main stand has to be removed |
| 2) der Seitenständer ist gemäß Montageanleitung um ca. 15 mm zu kürzen | 2) the side stand has to be shortened by approx. 15 mm according to mounting instructions |
| 3) Federbein muß abgepresst werden, nur bei OE Federbein montierbar | 3) the strut has to be pressure tested, can be mounted only with OE strut |
| 4) Federbein muß abgepresst werden, nur bei OE Federbein o. einstellbare Zugstufe montierbar | 4) the strut has to be pressure tested, can be mounted only with OE strut without adjustable tension level |
| 5) für Modell mit Original-Umlenkhebel mit Lochabstand größer als 100 mm | 5) for model with original relay arm with hole spacing over 100 mm |
| 6) Federvorspannung anpassen | 6) adapt pre-tension of spring |
| 7) die Zahl der Sitzplätze ist auf 1 reduziert, nicht mit Sozius | 7) the number of seats is reduced to 1, not with pillion |
| 8) Auspuffschele und Blende bei Montage lösen | 8) release exhaust clamp and cover for installation |
| 9) Absenkung der Telegabel möglich | 9) lowering of front fork possible |
| 10) Spritzschutz Hinterrad entfernen | 10) remove mud guard on rear wheel for fitting |
| 11) Seitenständer um 10 mm kürzen bei abgesenkter Telegabel bei 20 mm | 11) shorten side stand by 10 mm, by 20 mm with lowered front fork |
| 12) Kettenspannung prüfen | 12) Check chain tension |
| 13) Seitenständer anpassen | 13) Adapt kickstand |
| 14) Mitgelieferte Buchsen zwischen Federbeinaufnahme und TRW Bauteil montieren | 14) Install the included bushes between the strut mount and the TRW component |
| 15) Originalschrauben können verwendet werden | 15) The original screws can be used |

Typen der Höhenänderung:	Typ 01	Dreiecksplatten	Triangle plates
	Typ 02	Aufnahme für Federbeinauge	Seating for strut eye
	Typ 03	Zugstrebe	Tie rod
	Typ 04	Distanzstück (Frästeil) für Stereofederbeine	Spacer (milled part) for stereo shocks
	Typ 05	Distanzstück (Frästeil) für Stereofederbeine	Spacer (milled part) for stereo shocks
	Typ 06	Zugstrebe inkl. Lager	Tie rod
	Typ 07	Aufnahme für Federbeingabel	Seating for strut fork
	Typ 08	Zugstrebe	Tie rod
	Typ 09	Federbeinaufnahme BMW	Strut seating BMW
	Typ 10	Federteller	Spring plate

Kennzeichenhalter & Kettenschutz

Registration plate holders & chain guards



Kennzeichenhalter

Registration plate holder

FORMSCHÖNER, LEICHTER KENNZEICHENHALTER

- sehr edel aus Aluminium, schwarz beschichtet
- inkl. aller Montageteile, einfach an den Originalpunkten zu montieren
- alle Nummernschildhalter werden, wenn nicht anders angegeben, ohne Beleuchtungselemente geliefert
- bei Bedarf kann die Kennzeichenleuchte MSH 900 oder MSH 902 zusätzlich ausgewählt werden (siehe Seite 5.73)
- bei den meisten Modellen können die Original-Blinker nicht verwendet werden

ATTRACTIVELY FORMED, LIGHTWEIGHT REGISTRATION PLATE HOLDER

- high quality aluminium, with black coating
- includes all components, easy to mount at the original points
- unless otherwise indicated, all registration plate holders will be supplied without lighting elements
- the MSH 900 or MSH 902 license plate light can also be selected if necessary (see page 5.73)
- for most models, the original indicators cannot be used



UNIVERSALHALTER

- zum Selbsteinpassen

UNIVERSAL HOLDER

- can be adjusted to fit all marks



Bestell-Nr. | Order no.

MSH400

VARIO-UNIVERSALHALTER

- verstellbar

VARIABLE UNIVERSAL HOLDER

- adjustable



Bestell-Nr. | Order no.

MSH401

SCHRAUBENSET

- 3-tlg mit M5-Gewinde
- zur Montage des Nummernschildes

3-PIECE SCREW SET

- with M5 thread
- for mounting of the registration plate



Bestell-Nr. | Order no.

MSH901

NUMMERNSCHILD-BELEUCHTUNG

- Kunststoffgehäuse

REGISTRATION PLATE LIGHTING

- Plastic housing



Bestell-Nr. | Order no.

MSH900

NUMMERNSCHILD-BELEUCHTUNG

- LED, gefrästes Alugehäuse

REGISTRATION PLATE LIGHTING

- LED, milled aluminium frame



Bestell-Nr. | Order no.

MSH902

UNIVERSAL-BELEUCHTUNG

- zur einfachen Montage an der Heckunterverkleidung

UNIVERSAL LIGHT

- for easy mounting on the lower side of rear fairing



Bestell-Nr. | Order no.

MSH903

Motorcycle Icon		Hourglass Icon		Umbrella Icon		MSH900 Icon		MSH902 Icon		Info Icon	
BMW											
S	1000	RR	K10	09-14	MSH 130	Original					
S	1000	R		14-	MSH 130	Original					
Honda											
CBR	1000	RR	SC57	04-07	MSH 102	MSH 900	MSH 902			1)	
Kawasaki											
ZX-6R	600	Ninja	ZX600R	09-12	MSH 207	Original					
ZX-6R	636	Ninja	ZX636F	13-17	MSH 207	Original					
Z	750		ZR750L	07-10	MSH 206	MSH 900	MSH 902				
Z	750	R	ZR750N	11-12	MSH 206	MSH 900	MSH 902				
Z	1000		ZRT00B	07-09	MSH 206	MSH 900	MSH 902				
ZX-10R	1000	Ninja	ZXT00E	08-10	MSH 207	Original					
Suzuki											
SV	650		WVBY	03-10	MSH 300	Original					
GSX-S	750		WC50	17-	MSH 312						
SV	1000		WVBX	03-08	MSH 300	Original					
Yamaha											
FZ6	600	N	RJ07	04-06	MSH 503	MSH 900	MSH 902				
YZF	600	R6	RJ05, RJ09	03-05	MSH 500	MSH 900	MSH 902				
YZF	1000	R1	RN09	02-03	MSH 500	MSH 900	MSH 902				
YZF	1000	R1	RN12	04-06	MSH 502	MSH 900	MSH 902				

1) Seitenverkleidung von Auspuff muss entfernt werden

1) Exhaust side cover must be removed



Einbaubeispiel | Installation example

Kettenschützer aus Aluminium Aluminium chain guards

UNIVERSAL KETTENSCHÜTZER

- formschönes, attraktives Design
- hochwertige Ausführung
- metallische Pulverbeschichtung
- korrosionsgeschützte Oberfläche
- leicht zu reinigen und zu pflegen
- stabile, passgenaue Konstruktion

UNIVERSAL CHAIN GUARD

- attractive design with beautiful lines
- high-quality product
- metallic powder coating
- corrosion-resistant surface
- easy to clean and maintain
- robust, accurately-fitting design



Bestell-Nr. Order no.	
Silber Silver	Schwarz Black
MCK2222	MCK2222S

Universal-Kettenschutz mit maximalem Befestigungsbereich von 377 mm
Universal chain guard with maximum fitting range of 377 mm



Passend für fast alle Modelle ohne Schwingenoberzug!

Fits most models without top-mounted stabiliser on swingarm!



XDB500L • 70242 EN  2019-

trwmoto.com

TRW

TRW KFZ Ausrüstung GmbH
Rudolf-Diesel-Str. 7
56566 Neuwied
Germany

Telefon +49 (0) 2631 912 0
Telefax +49 (0) 2631 912 110

© TRW Automotive 2019

Printed in Germany 28M/0319/Tabula rasa GmbH